

User Tutorial

The OpenMS Developers

May 9, 2021

**Creative Commons Attribution 4.0 International
(CC BY 4.0)**

Contents

1	General remarks	7
2	Getting started	8
2.1	Installation	8
2.1.1	Installation from the OpenMS USB stick	8
2.1.2	Installation from the internet	9
2.2	Data conversion	9
2.2.1	MSConvertGUI	10
2.2.2	msconvert	10
2.2.3	ThermoRawFileParser	11
2.3	Data visualization using TOPPView	11
2.4	Introduction to KNIME / OpenMS	15
2.4.1	Plugin and dependency installation	15
2.4.2	KNIME concepts	18
2.4.3	Overview of the graphical user interface	19
2.4.4	Creating workflows	21
2.4.5	Sharing workflows	22
2.4.6	Duplicating workflows	22
2.4.7	A minimal workflow	22
2.4.8	Digression: Working with chemical structures	25
2.4.9	Advanced topic: Metanodes	27
2.4.10	Advanced topic: R integration	27
3	Label-free quantification of peptides	30
3.1	Introduction	30
3.2	Peptide Identification	30
3.2.1	Bonus task: identification using several search engines	33
3.3	Quantification	35
3.4	Combining quantitative information across several label-free experiments	36
3.4.1	Basic data analysis in KNIME	38
3.5	Identification & Quantification of the iPRG2015 data with subsequent MSstats analysis	39
3.5.1	Excursion MSstats	40
3.5.2	Dataset	40
3.5.3	Identification and Quantification	40
3.5.4	Experimental design	42
3.5.5	Conversion and downstream analysis	43

3.5.6	Result	47
4	Protein Inference	49
4.1	Extending the LFQ workflow by protein inference and quantification	49
4.2	Statistical validation of protein inference results	51
4.2.1	Data preparation	51
4.2.2	ROC curve of protein ID	51
4.2.3	Posterior probability and FDR of protein IDs	52
5	Isobaric analysis	54
5.1	Isobaric analysis workflow	54
5.2	Excursion MSstatsTMT	55
5.3	Dataset & Experimental Design	55
5.3.1	MSstatsTMT analysis	56
5.4	Note	59
6	Label-free quantification of metabolites	61
6.1	Introduction	61
6.2	Basics of non-targeted metabolomics data analysis	61
6.3	Basic metabolite identification	68
6.3.1	Convert your data into a KNIME table	70
6.3.2	Adduct grouping	70
6.3.3	Visualizing data	72
6.3.4	Spectral library search	73
6.3.5	Manual validation	74
6.3.6	<i>De novo</i> identification	75
6.4	Downstream data analysis and reporting	77
6.4.1	Signal processing and data preparation for identification	77
6.4.2	Data preparation for quantification	78
6.4.3	Statistical analysis	78
6.4.4	Interactive visualization	79
6.4.5	Advanced visualization	80
6.4.6	Data preparation for Reporting	81
7	OpenSWATH	83
7.1	Introduction	83
7.2	Installation of OpenSWATH	83
7.3	Installation of mProphet	83
7.4	Generating the Assay Library	84
7.4.1	Generating TraML from transition lists	84

7.4.2	Appending decoys to a TraML file	86
7.5	OpenSWATH KNIME	86
7.6	From the example dataset to real-life applications	87
8	OpenSWATH for Metabolomics	89
8.1	Introduction	89
8.2	Workflow	89
8.3	Prerequisites	89
8.3.1	Windows	90
8.3.2	MacOS	90
8.3.3	Linux	91
8.4	Benchmark data	91
8.5	Example Workflow	91
8.6	Run the Workflow	92
8.7	Important parameters	93
9	An introduction to pyOpenMS	96
9.1	Introduction	96
9.2	Installation	96
9.2.1	Windows	96
9.2.2	MacOS	96
9.2.3	Linux	97
9.2.4	IDE with Anaconda integration	97
9.3	Build instructions	98
9.4	Scripting with pyOpenMS	98
9.5	Tool development with pyOpenMS	100
9.5.1	Basics	100
9.5.2	Loading data structures with pyOpenMS	100
9.5.3	Putting things together	102
9.5.4	Bonus task	102
10	Quality control	104
10.1	Introduction	104
10.2	Building a qcML file per run	105
10.3	Adding brand new QC metrics	107
10.4	Set QC metrics	109
11	Troubleshooting guide	111
11.1	FAQ	111
11.1.1	How to debug KNIME and/or the OpenMS nodes?	111

11.1.2 General	112
11.1.3 Platform-specific problems	113
11.1.4 Nodes	114
11.2 Sources of support	114

1 General remarks

- This handout will guide you through an introductory tutorial for the OpenMS/TOPP software package [1].
- OpenMS [2, 3] is a versatile open-source library for mass spectrometry data analysis. Based on this library, we offer a collection of command-line tools ready to be used by end users. These so-called TOPP tools (short for "The OpenMS Proteomics Pipeline") [4] can be understood as small building blocks of arbitrarily complex data analysis workflows.
- In order to facilitate workflow construction, OpenMS was integrated into KNIME [5], the Konstanz Information Miner, an open-source integration platform providing a powerful and flexible workflow system combined with advanced data analytics, visualization, and report capabilities. Raw MS data as well as the results of data processing using TOPP can be visualized using TOPPView [6].
- This tutorial was designed for use in a hands-on tutorial session but can also be worked through at home using the online resources. You will become familiar with some of the basic functionalities of OpenMS/TOPP, TOPPView, as well as KNIME and learn how to use a selection of TOPP tools used in the tutorial workflows.
- All sample data referenced in this tutorial can be found in the  C: / Example_Data folder, on the USB stick that came with this tutorial, or released online on our GitHub repository OpenMS/Tutorials.

2 Getting started

2.1 Installation

Before we get started we will install OpenMS and KNIME. If you take part in a training session you will have likely received an USB stick from us that contains the required data and software. If we provide laptops with the software you may of course skip the installation process and continue reading the next section.

2.1.1 Installation from the OpenMS USB stick

Please choose the directory that matches your operating system and execute the installer.

For example for **Windows** you call

- the OpenMS installer: `Windows / OpenMS-2.6.0-Win64.exe`
- the KNIME installer: `Windows / KNIME-4.2.0-Installer-64bit.exe`
- OpenMS prerequisites (Windows-only): After installation, before your first use of the OpenMS plugin in KNIME you will be asked to download it automatically if certain requirements are not found in your Windows registry. Alternatively, you can get a bundled version here or on the OpenMS USB stick (`Windows / OpenMS-2.6-prerequisites-installer.exe`).

on **macOS** you call

- the OpenMS installer: `Mac / OpenMS-2.6.0-macOS.dmg`
- the KNIME installer: `Mac / knime_4.2.0.app.macosx.cocoa.x86_64.dmg`

and follow the instructions. For the OpenMS installation on **macOS**, you need to accept the license drag and drop the OpenMS folder into your Applications folder.

Note: Due to increasing security measures for downloaded apps (e.g. path randomization) on **macOS** you might need to open TOPPView.app and TOPPAS.app while holding `ctrl` and accept the warning. If the app still does not open, you might need to move them from `Applications` to `OpenMS-2.6.0` to e.g. your Desktop and back.

On **Linux** you can extract KNIME to a folder of your choice and for TOPPView you need to install OpenMS via your package manager or build it on your own with the instructions under www.openms.de/documentation.

Note: If you have installed OpenMS on Linux or macOS via your package manager (for instance by installing the OpenMS-2.6.0-Linux.deb package), then you need to set the OPENMS_DATA_PATH variable to the directory containing the shared data (normally /usr/share/OpenMS). This must be done prior to running any TOPP tool.

2.1.2 Installation from the internet

If you are working through this tutorial at home you can get the installers under the following links:

- OpenMS: <https://www.openms.de/download/openms-binaries>
- KNIME: <https://www.knime.org/downloads/overview>
- OpenMS prerequisites (Windows-only): After installation, before your first use of the OpenMS plugin in KNIME you will be asked to download it automatically if certain requirements are not found in your Windows registry. Alternatively, you can get a bundled version [here](#).

Choose the installers for the platform you are working on.

2.2 Data conversion

Each MS instrument vendor has one or more formats for storing the acquired data. Converting these data into an open format (preferably mzML) is the very first step when you want to work with open-source mass spectrometry software. A freely available conversion tool is MSConvert, which is part of a ProteoWizard installation. All files used in this tutorial **have already been converted to mzML** by us, so you do not need to perform the data conversion yourself. However, we provide a small raw file so you can try the important step of raw data conversion for yourself.

Note: The OpenMS installation package for Windows automatically installs ProteoWizard, so you do not need to download and install it separately. Due to restrictions from the instrument vendors, file format conversion for most formats is **only possible on Windows** systems. In practice, performing the conversion to mzML on the acquisition PC connected to the instrument is usually the most convenient option.

To convert raw data to mzML using ProteoWizard you can either use MSConvertGUI (a graphical user interface) or msconvert (a simple command line tool). Both tools are

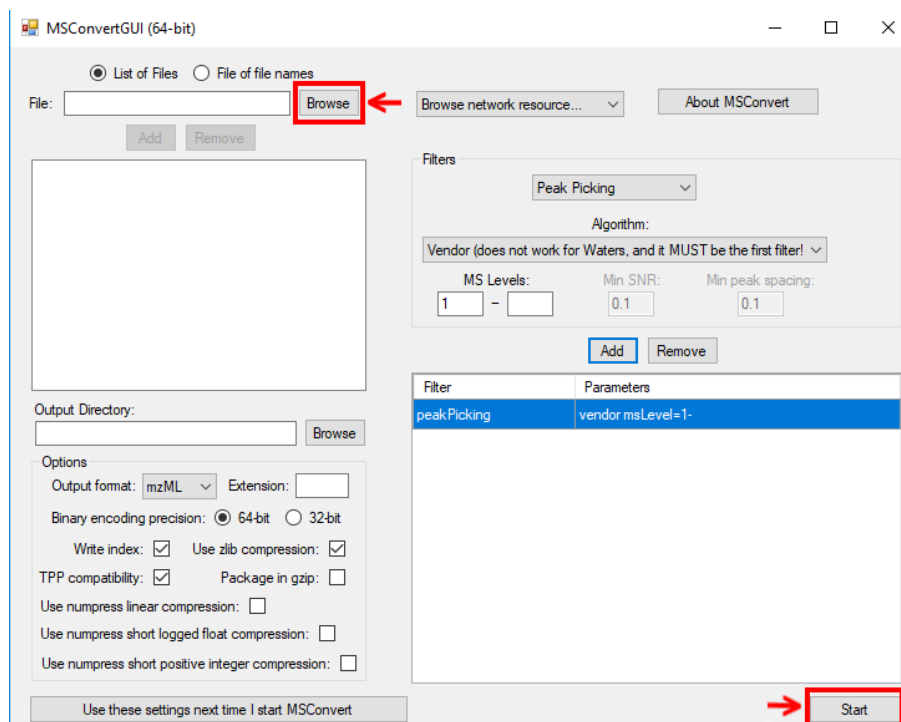

Figure 1: MSConvertGUI (part of ProteoWizard), allows converting raw files to mzML. Select the raw files you want to convert by clicking on the browse button and then on Add. Default parameters can usually be kept as-is. To reduce the initial data size, make sure that the peakPicking filter (converts profile data to centroided data (see Fig. 2)) is listed, enabled (true) and applied to all MS levels (parameter "1-"). Start the conversion process by clicking on the Start button.

available in:

C: / Program Files / OpenMS-2.6.0 / share / OpenMS / THIRDPARTY / pwiz-bin.
 You can find a small RAW file on the USB stick C: / Example_Data / Introduction / datasets / raw.

2.2.1 MSConvertGUI

MSConvertGUI (see Fig. 1) exposes the main parameters for data conversion in a convenient graphical user interface.

2.2.2 msconvert

The `msconvert` command line tool has no user interface but offers more options than the application MSConvertGUI. Additionally, since it can be used within a batch script, it allows converting large numbers of files and can be much more easily automatized. To convert and pick the file *raw_data_file.RAW* you may write:

```
msconvert raw_data_file.RAW --filter "peakPicking true 1-"
```

in your command line.

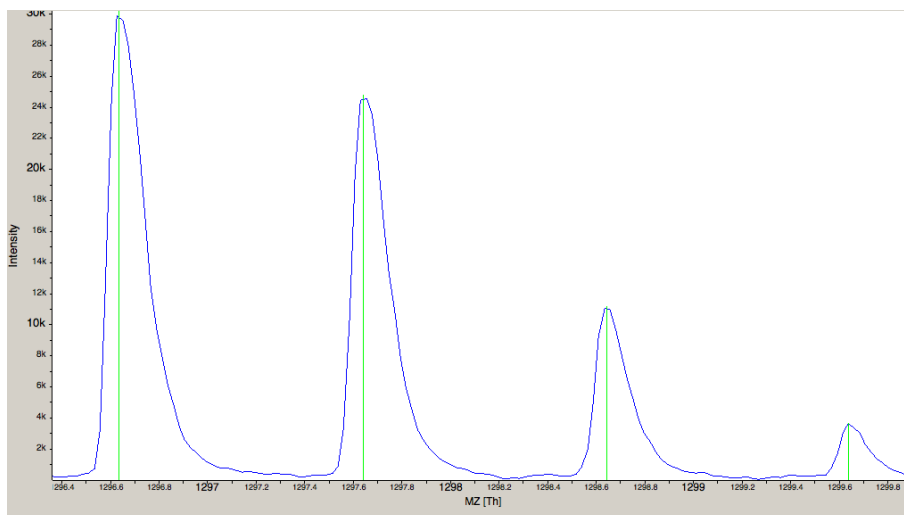

Figure 2: The amount of data in a spectra is reduced by peak picking. Here a profile spectrum (blue) is converted to centroided data (green). Most algorithms from this point on will work with centroided data.

To convert all RAW files in a folder may write:

```
msconvert *.RAW -o my_output_dir
```

Note: To display all options you may type `msconvert --help`. Additional information is available on the ProteoWizard web page.

2.2.3 ThermoRawFileParser

Recently the open-source platform independent ThermoRawFileParser tool has been developed. While Proteowizard and MSConvert are only available for Windows systems this new tool allows to also convert raw data on Mac or Linux.

Note: To learn more about the ThermoRawFileParser and how to use it in KNIME see Section 2.4.7

2.3 Data visualization using TOPPView

Visualizing the data is the first step in quality control, an essential tool in understanding the data, and of course an essential step in pipeline development. OpenMS provides a convenient viewer for some of the data: TOPPView.

We will guide you through some of the basic features of TOPPView. Please familiarize yourself with the key controls and visualization methods. We will make use of these later throughout the tutorial. Let's start with a first look at one of the files of our tutorial data set. Note that conceptually, there are no differences in visualizing metabolomic or proteomic data. Here, we inspect a simple proteomic measurement:

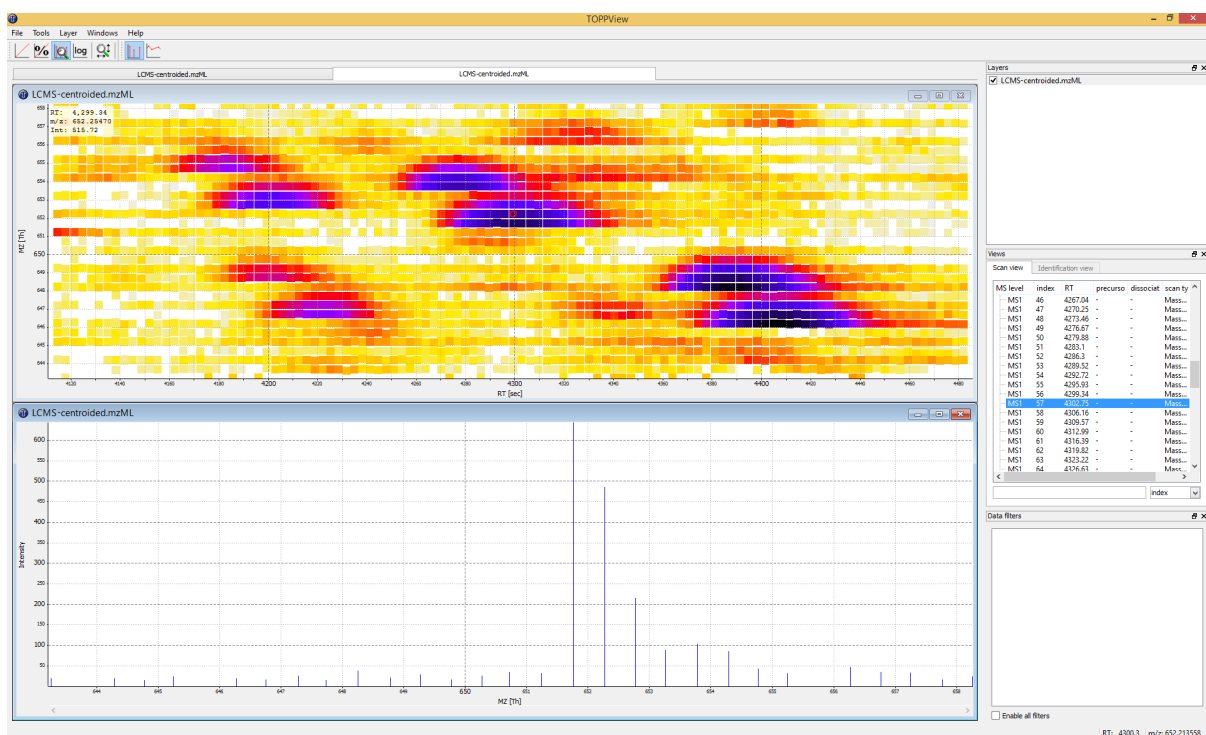

Figure 3: TOPPView, the graphical application for viewing mass spectra and analysis results. Top window shows a small region of a peak map. In this 2D representation of the measured spectra, signals of eluting peptides are colored according to the raw peak intensities. The lower window displays an extracted spectrum (=scan) from the peak map. On the right side, the list of spectra can be browsed.

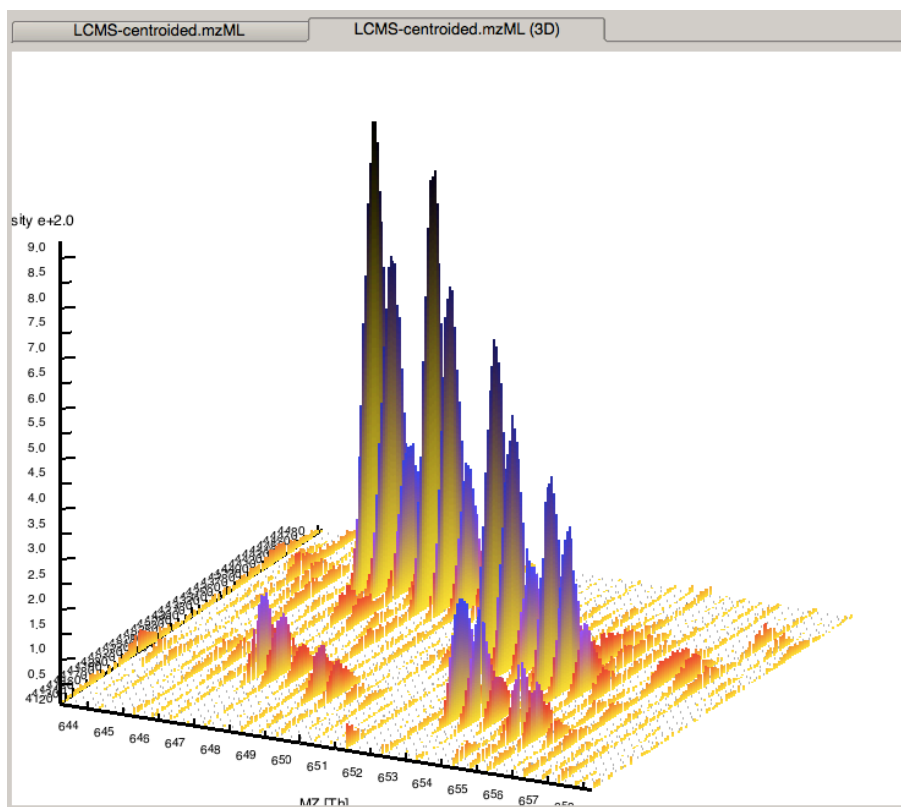

Figure 4: 3D representation of the measured spectra, signals of eluting peptides are colored according to the raw peak intensities.

- Start TOPPView (see **Windows'** Start-Menu or Applications ▶ OpenMS-2.4.0 on **macOS**)
- Go to File > Open File, navigate to the directory where you copied the contents of the USB stick to, and select Example_Data ▶ Introduction ▶ datasets ▶ small ▶ velos005614.mzML . This file contains only a reduced LC-MS map¹ of a label-free proteomic platelet measurement recorded on an Orbitrap velos. The other two mzML files contain technical replicates of this experiment. First, we want to obtain a global view on the whole LC-MS map - the default option **Map view 2D** is the correct one and we can click the Ok button.
- Play around.
- Three basic modes allow you to interact with the displayed data: scrolling, zooming and measuring:
 - Scroll mode
 - * Is activated by default (though each loaded spectra file is displayed zoomed out first, so you do not need to scroll).

¹only a selected RT and m/z range was extracted using the TOPP tool FileFilter

- * Allows you to browse your data by moving around in RT and m/z range.
 - * When zoomed in, you can scroll through the spectra. Click-drag on the current view.
 - * Arrow keys can be used to scroll the view as well.
- Zoom mode
- * Zooming into the data: either mark an area in the current view with your mouse while holding the left mouse button plus the **Ctrl** key to zoom to this area or use your mouse wheel to zoom in and out.
 - * All previous zoom levels are stored in a zoom history. The zoom history can be traversed using **Ctrl**+**+** or **Ctrl**+**-** or the mouse wheel (scroll up and down).
 - * Pressing backspace **←** zooms out to show the full LC-MS map (and also resets the zoom history).
- Measure mode
- * It is activated using the **⇧** (shift) key.
 - * Press the left mouse button down while a peak is selected and drag the mouse to another peak to measure the distance between peaks.
 - * This mode is implemented in the 1D and 2D mode only.
- Right click on your 2D map and select **Switch to 3D view** and examine your data in 3D mode (see Fig. 4)
 - Go back to the 2D view. In 2D mode, visualize your data in different intensity normalization modes, use linear, percentage, snap and log-view (icons on the upper left tool bar). You can hover over the icons for additional information.
- Note:** On *macOS*, due to a bug in one of the external libraries used by OpenMS, you will see a small window of the 3D mode when switching to 2D. Close the 3D tab in order to get rid of it.
- In TOPPView you can also execute TOPP tools. Go to **Tools** > **Apply tool (whole layer)** and choose a TOPP tool (e.g., FileInfo) and inspect the results.

Dependent on your data MS/MS spectra can be visualized as well (see Fig.5) . You can do so, by double-click on the MS/MS spectrum shown in scan view.

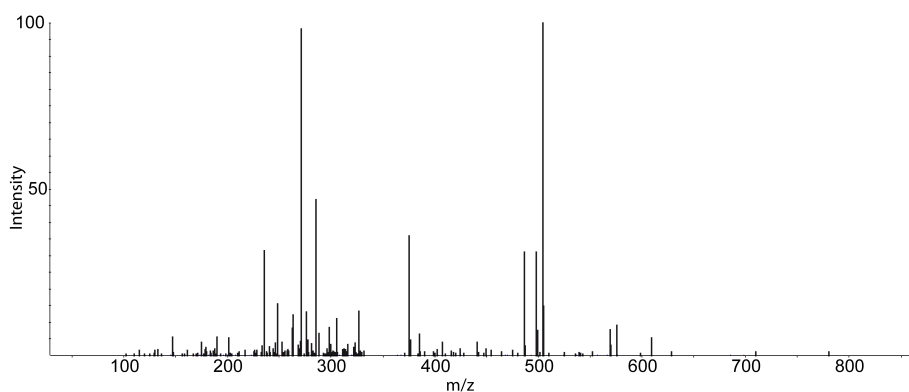

Figure 5: MS/MS spectrum

2.4 Introduction to KNIME / OpenMS

Using OpenMS in combination with KNIME, you can create, edit, open, save, and run workflows that combine TOPP tools with the powerful data analysis capabilities of KNIME. Workflows can be created conveniently in a graphical user interface. The parameters of all involved tools can be edited within the application and are also saved as part of the workflow. Furthermore, KNIME interactively performs validity checks during the workflow editing process, in order to make it more difficult to create an invalid workflow.

Throughout most parts of this tutorial you will use KNIME to create and execute workflows. The first step is to make yourself familiar with KNIME. Additional information on basic usage of KNIME can be found on the KNIME Getting Started page. However, the most important concepts will also be reviewed in this tutorial.

2.4.1 Plugin and dependency installation



Before we can start with the tutorial we need to install all the required extensions for KNIME. Since KNIME 3.2.1 the program automatically detects missing plugins when you open a workflow but to make sure that the right source for the OpenMS plugin is chosen, please follow the instructions here. First, we install some additional extensions that are required by our OpenMS nodes or used in the Tutorials e.g. for visualization and file handling.

1. Click on Help Install New Software...
2. From the Work with: drop-down list select <http://update.knime.com/analytics-platform/4.2>
3. Now select the following plugins from the *KNIME & Extensions* category
 - KNIME Base Chemistry Types & Nodes
 - KNIME Chemistry Add-Ons

```
install.packages('Rserve', "http://rforge.net/", type="source")
install.packages("Cairo")
install.packages("devtools")
install.packages("ggplot2")
install.packages("ggfortify")
if (!requireNamespace("BiocManager", quietly = TRUE))
  install.packages("BiocManager")
BiocManager::install()
BiocManager::install(c("MSstats"))
```

- KNIME File Handling Nodes (required for OpenMS nodes in general)
 - KNIME Interactive R Statistics Integration
 - KNIME Report Designer
 - KNIME SVG Support
4. Click on and follow the instructions (you may but don't need to restart KNIME now)
 5. Click again on
 6. From the drop-down list select
 7. Now select the following plugin from the "KNIME Community Contributions - Cheminformatics" category
 - RDKit KNIME integration
 8. Click on and follow the instructions and after a restart of KNIME the dependencies will be installed.

In addition, we need to install R for the statistical downstream analysis. Choose the directory that matches your operating system, double-click the R installer and follow the instructions. We recommend to use the default settings whenever possible. On macOS you also need to install XQuartz from the same directory.

Afterwards open your R installation. If you use Windows, you will find an "R x64 3.6.X" icon on your desktop. If you use macOS, you will find R in your Applications folder. In R type the following lines (you might also copy them from the file  R  install_R_packages.R folder on the USB stick):

In KNIME, click on , select the category and set the "Path to R Home" to your installation path. You can use the following settings, if you installed R as described above:





- Windows: C:\Program Files\R\R-3.6.X (where X is the version you used to install the above libraries)

- macOS: /Library/Frameworks/R.framework/Versions/3.6/Resources

You are now ready to install the OpenMS nodes.

- Open KNIME.
- Click on  

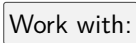

We included a custom KNIME update site to install the OpenMS KNIME plugins from the USB stick. If you do not have a stick available, please see below.

- In the now open dialog choose  (in the upper right corner of the dialog) to define a new update site. In the opening dialog enter the following details.
Name: OpenMS 2.4 UpdateSite
Location: file:/KNIMEUpdateSite/2.6.0/
- After pressing  KNIME will show you all the contents of the added Update Site.
- **Note:** From now on, you can use this repository for plugins in the  drop-down list.
- Select the **OpenMS** nodes in the "Uncategorized" category and click .
- Follow the instructions and after a restart of KNIME the OpenMS nodes will be available in the Node repository under "Community Nodes".

Alternatively, you can try these steps that will install the OpenMS KNIME plugins from the internet. Note that download can be slow.

- In the now open dialog choose  (in the upper right corner of the dialog) to define a new update site. In the opening dialog enter the following details.
Name: OpenMS 2.5 UpdateSite
Location:

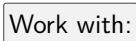
 <https://abibuilder.informatik.uni-tuebingen.de/archive/openms/knime-plugin/updateSite/nightly/>

- After pressing  KNIME will show you all the contents of the added Update Site.
- **Note:** From now on, you can use this repository for plugins in the  drop-down list.
- Select the **OpenMS** nodes in the "Uncategorized" category and click .
- Follow the instructions and after a restart of KNIME the OpenMS nodes will be available in the Node repository under "Community Nodes".

2.4.2 KNIME concepts

A **workflow** is a sequence of computational steps applied to a single or multiple input data to process and analyze the data. In KNIME such workflows are implemented graphically by connecting so-called **nodes**. A node represents a single analysis step in a workflow. Nodes have input and output **ports** where the data enters the node or the results are provided for other nodes after processing, respectively. KNIME distinguishes between different port types, representing different types of data. The most common representation of data in KNIME are tables (similar to an excel sheet). Ports that accept tables are marked with a small triangle. For OpenMS nodes, we use a different port type, so called **file ports**, representing complete files. Those ports are marked by a small blue box. Filled blue boxes represent mandatory inputs and empty blue boxes optional inputs. The same holds for output ports, despite you can deactivate them in the configuration dialog (double-click on node) under the OutputTypes tab. After execution, deactivated ports will be marked with a red cross and downstream nodes will be inactive (not configurable).

A typical OpenMS workflow in KNIME can be divided in two conceptually different parts:

- Nodes for signal and data processing, filtering and data reduction. Here, files are passed between nodes. Execution times of the individual steps are typically longer for these types of nodes as they perform the main computations.
- Downstream statistical analysis and visualization. Here, tables are passed between nodes and mostly internal KNIME nodes or nodes from third-party statistics plugins are used. The transfer from files (produced by OpenMS) and tables usually happens with our provided Exporter and Reader nodes (e.g. MzTabExporter followed by MzTabReader).

Moreover, nodes can have three different states, indicated by the small traffic light below the node.

- Inactive, failed, and not yet fully configured nodes are marked red.
- Configured but not yet executed nodes are marked yellow.
- Successfully executed nodes are marked green.

If the node execution fails, the node will switch to the red state. Other anomalies and warnings like missing information or empty results will be presented with a yellow exclamation mark above the traffic light. Most nodes will be configured as soon as all input ports are connected. Some nodes need to know about the output of the predecessor and may stay red until the predecessor was executed. If nodes

still remain in a red state, probably additional parameters have to be provided in the configuration dialog that can neither be guessed from the data nor filled with sensible defaults. In this case, or if you want to customize the default configuration in general, you can open the configuration dialog of a node with a double-click on the node. For all OpenMS nodes you will see a configuration dialog like the one shown in Figure 6.

Note: OpenMS distinguishes between normal parameters and advanced parameters. Advanced parameters are by default hidden from the users since they should only rarely be customized. In case you want to have a look at the parameters or need to customize them in one of the tutorials you can show them by clicking on the checkbox Show advanced parameter in the lower part of the dialog. Afterwards the parameters are shown in a light gray color.

The dialog shows the individual parameters, their current value and type, and, in the lower part of the dialog, the documentation for the currently selected parameter. Please also note the tabs on the top of the configuration dialog. In the case of OpenMS nodes, there will be another tab called *OutputTypes*. It contains dropdown menus for every output port that let you select the output filetype that you want the node to return (if the tool supports it). For optional output ports you can select *Inactive* such that the port is crossed out after execution and the associated generation of the file and possible additional computations are not performed. Note that this will deactivate potential downstream nodes connected to this port.

2.4.3 Overview of the graphical user interface

The graphical user interface (GUI) of KNIME consists of different components or so-called panels that are shown in Figure 7. We will briefly introduce the individual panels and their purposes below.

Workflow Editor: The workflow editor is the central part of the KNIME GUI. Here you assemble the workflow by adding nodes from the Node Repository via "drag & drop". For quick creation of a workflow, note that double-clicking on a node in the repository automatically connects it to the selected node in the workbench (connecting all the inputs with as many fitting outputs of the last node). Manually, nodes can be connected by clicking on the output port of one node and dragging the edge until releasing the mouse at the desired input port of the next node. Deletions are possible by selecting nodes and/or edges and pressing or depending on your OS and settings. Multiselection happens via dragging rectangles with the mouse or adding elements to the selection by clicking them while holding down .

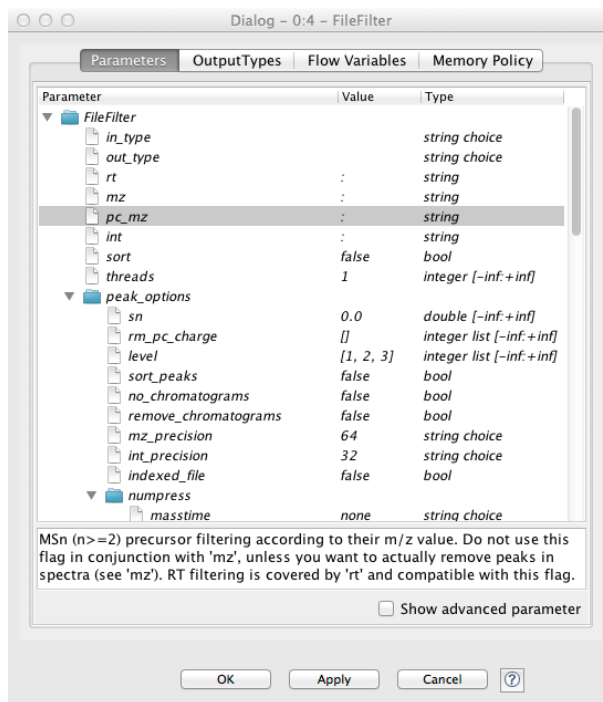

Figure 6: Node configuration dialog of an OpenMS node.

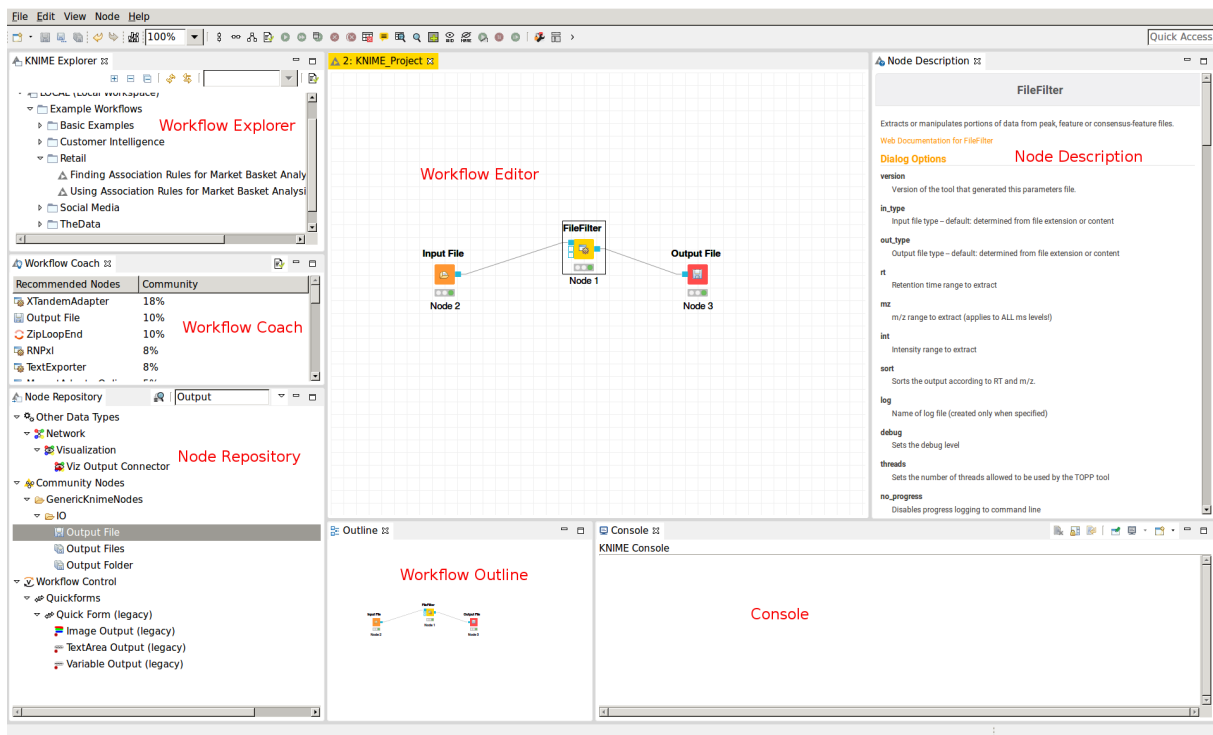

Figure 7: The KNIME workbench.

KNIME Explorer: Shows a list of available workflows (also called workflow projects). You can open a workflow by double-clicking it. A new workflow can be created with a right-click in the Workflow Explorer followed by choosing `New KNIME Workflow...` from the appearing context menu. Remember to save your workflow often with the `Ctrl+S` shortcut.

Workflow Coach (since KNIME 3.2.1): Shows a list of suggested following nodes, based on the last added/clicked nodes. When you are not sure which node to choose next, you have a reasonable suggestion based on other users behavior there. Connect them to the last node with a double-click.

Node Repository: Shows all nodes that are available in your KNIME installation. Every plugin you install will provide new nodes that can be found here. The OpenMS nodes can be found in `Community Nodes >> OpenMS`. Nodes for managing files (e.g., Input Files or Output Folders) can be found in `Community Nodes >> GenericKnimeNodes`. You can search the node repository by typing the node name into the small text box in the upper part of the node repository.

Outline: The Outline panel contains a small overview of the complete workflow. While of limited use when working on a small workflow, this feature is very helpful as soon as the workflows get bigger. You can adjust the zoom level of the explorer by adjusting the percentage in the toolbar at the top of KNIME.

Console: In the console panel warning and error messages are shown. This panel will provide helpful information if one of the nodes failed or shows a warning sign.

Node Description: As soon as a node is selected, the Node Description window will show the documentation of the node including documentation for all its parameters and especially their in- and outputs, such that you know what types of data nodes may produce or expect. For OpenMS nodes you will also find a link to the tool page of the online documentation.

2.4.4 Creating workflows

Workflows can easily be created by a right click in the Workflow Explorer followed by clicking on `New KNIME Workflow...`.

2.4.5 Sharing workflows

To be able to share a workflow with others, KNIME supports the import and export of complete workflows. To export a workflow, select it in the Workflow Explorer and select **File** > **Export KNIME Workflow...**. KNIME will export workflows as a *knwf* file containing all the information on nodes, their connections, and their parameter configuration. Those *knwf* files can again be imported by selecting **File** > **Import KNIME Workflow...**.

Note: For your convenience we added all workflows discussed in this tutorial to the  **Workflows** folder on the USB Stick. Additionally, the workflow files can be found on our GitHub repository. If you want to check your own workflow by comparing it to the solution or got stuck, simply import the full workflow from the corresponding *knwf* file and after that double-click it in your KNIME Workflow repository to open it.

2.4.6 Duplicating workflows

In this tutorial, a lot of the workflows will be created based on the workflow from a previous task. To keep the intermediate workflows, we suggest you create copies of your workflows so you can see the progress. To create a copy of your workflow, save it, close it and follow the next steps.

- Right click on the workflow you want to create a copy of in the Workflow Explorer and select **Copy**.
- Right click again somewhere on the workflow explorer and select **Paste**.
- This will create a workflow with same name as the one you copied with a (2) appended.
- To distinguish them later on you can easily rename the workflows in the Workflow Explorer by right clicking on the workflow and selecting **Rename**.

Note: To rename a workflow it has to be closed, too.

2.4.7 A minimal workflow

Let us now start with the creation of our very first, very simple workflow. As a first step, we will gather some basic information about the data set before starting the actual development of a data analysis workflow. This minimal workflow can also be used to check if all requirements are met and that your system is compatible.

- Create a new workflow.

- Add an Input File node and an Output Folder node (to be found in Community Nodes GenericKnomeNodes IO) and a FileInfo node (to be found in the category Community Nodes OpenMS File Handling) to the workflow.

- Connect the Input File node to the FileInfo node, and the first output port of the FileInfo node to the Output Folder node.

Note: In case you are unsure about which node port to use, hovering the cursor over the port in question will display the port name and what kind of input it expects.

The complete workflow is shown in Figure 8. FileInfo can produce two different kinds of output files.

- All nodes are still marked red, since we are missing an actual input file. Double-click the Input File node and select Browse. In the file system browser select Example_Data Introduction datasets tiny velos005614.mzML and click Open. Afterwards close the dialog by clicking Ok.

Note: Make sure to use the “tiny” version this time, not “small”, for the sake of faster workflow execution.

- The Input File node and the FileInfo node should now have switched to yellow, but the Output Folder node is still red. Double-click on the Output Folder node and click on Browse to select an output directory for the generated data.
- Great! Your first workflow is now ready to be run. Press ↑ + F7 (shift key + F7; or the button with multiple green triangles in the KNIME Toolbar) to execute the complete workflow. You can also right click on any node of your workflow and select Execute from the context menu.
- The traffic lights tell you about the current status of all nodes in your workflow. Currently running tools show either a progress in percent or a moving blue bar, nodes waiting for data show the small word “queued”, and successfully executed ones become green. If something goes wrong (e.g., a tool crashes), the light will become red.
- In order to inspect the results, you can just right-click the Output Folder node and select View: Open the output folder. You can then open the text file and inspect its contents. You will find some basic information of the data contained in the mzML file, e.g., the total number of spectra and peaks, the RT and m/z range, and how many MS1 and MS2 spectra the file contains.

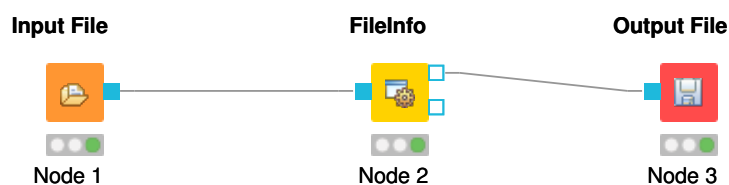

Figure 8: A minimal workflow calling FileInfo on a single file.

Workflows are typically constructed to process a large number of files automatically. As a simple example, consider you would like to convert multiple Thermo Raw files into the mzML format. We will now modify the workflow to compute the same information on three different files and then write the output files to a folder.

- We start from the previous workflow.
- First we need to replace our single input file with multiple files. Therefore we add the Input Files node from the category `Community Nodes >> GenericKnomeNodes >> IO`.
- To select the files we double-click on the Input Files node and click on `Add`. In the filesystem browser we select all three files from the directory `Example_Data >> Introduction >> datasets >> tiny >> .` And close the dialog with `Ok`.
- We now add two more nodes: the ZipLoopStart and the ZipLoopEnd node from the category `Community Nodes >> GenericKnomeNodes >> Flow`.
- Afterwards we connect the Input Files node to the first port of the ZipLoopStart node, the first port of the ZipLoopStart node to the FileConverter node, the first output port of the FileConverter node to the first input port of the ZipLoopEnd node, and the first output port of the ZipLoopEnd node to the Output Folder node (NOT to the Output File). The complete workflow is shown in Figure 9
- The workflow is already complete. Simply execute the workflow and inspect the output as before.

In case you had trouble to understand what ZipLoopStart and ZipLoopEnd do - here is a brief explanation:

- The Input Files node passes a list of files to the ZipLoopStart node.
- The ZipLoopStart node takes the files as input, but passes the single files sequentially (that is: one after the other) to the next node.
- The ZipLoopEnd collects the single files that arrive at its input port. After all files have been processed, the collected files are passed again as file list to the next node that follows.

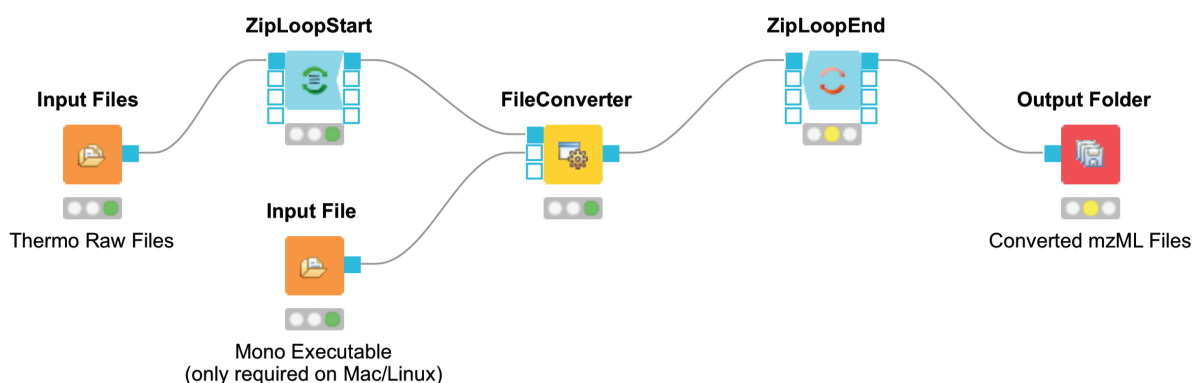

Figure 9: A minimal workflow calling the FileConverter on multiple Thermo Raw files in a loop.

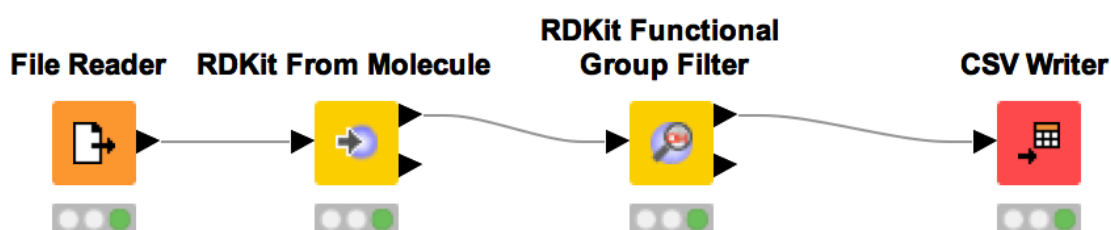

Figure 10: Workflow to visualize a list of SMILES strings and filter them by predefined substructures.

2.4.8 Digression: Working with chemical structures

Metabolomics analyses often involve working with chemical structures. Popular cheminformatics toolkits such as RDKit [7] or CDK [8] are available as KNIME plugins and allow us to work with chemical structures directly from within KNIME. In particular, we will use KNIME and RDKit to visualize a list of compounds and filter them by predefined substructures. Chemical structures are often represented as SMILES (**S**implified **m**olecular **i**nput **l**ine **e**ntry **s**pecification), a simple and compact way to describe complex chemical structures as text. For example, the chemical structure of L-alanine can be written as the SMILES string C[C@H](N)C(O)=O. As we will discuss later, all OpenMS tools that perform metabolite identification will report SMILES as part of their result, which can then be further processed and visualized using RDKit and KNIME.

Perform the following steps to build the workflow shown in in Fig. 10. You will use this workflow to visualize a list of SMILES strings and filter them by predefined substructures:

- Add the node `File Reader`, open the node configuration dialog and select the file `smiles.csv`. This file has been exported from the Human Metabolome

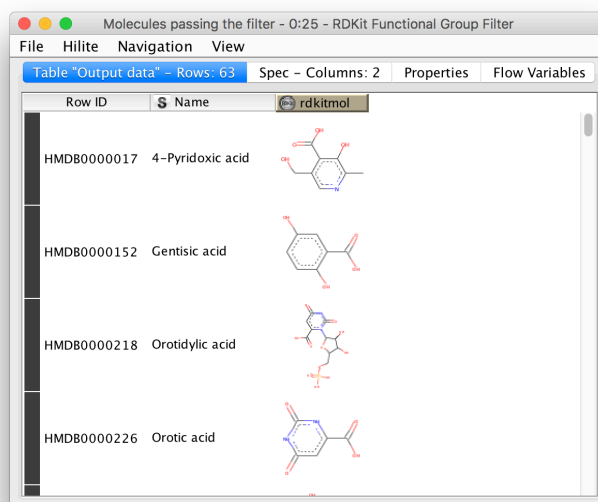

Figure 11: Resulting list of compounds that contains at least one aromatic carboxylic acid group.

Database (HMDB) and contains the portion of the human metabolome that has been detected and quantified. The file preview on the bottom of the dialog shows that each compound is given by its HMDB accession, compound name, and SMILES string. Click on the column header 'SMILES' to change its properties. Change the column type from 'string' to 'smiles' and close the dialog with . Afterwards the SMILES column will be visualized as chemical structures instead of text directly within all KNIME tables.

- Add the node `RDKit From Molecule` and connect it to the `File Reader`. This node will use the provided SMILES strings to add an additional column that is required by `RDKit`.
- Add the node `RDKit Functional Group Filter` and open the node configuration dialog. You can use this dialog to filter the compounds by any combination of functional groups. In this case we want to find all compounds that contain at least one aromatic carboxylic acid group. To do this, set this group as active and choose '>=' and '1'.
- Connect the first output port (`Molecules passing the filter`) to a `CSV Writer` node to save the filtered metabolites to a file. Right click `RDKit Functional Group Filter` and select the view '`Molecules passing the filter`' to inspect the selected compounds in KNIME. How many compounds pass the chosen filter (see Fig. 11)?

2.4.9 Advanced topic: Metanodes

Workflows can get rather complex and may contain dozens or even hundreds of nodes. KNIME provides a simple way to improve handling and clarity of large workflows:

Metanodes allow to bundle several nodes into a single Metanode.

Task

- ✓ Select multiple nodes (e.g. all nodes of the ZipLoop including the start and end node). To select a set of nodes, draw a rectangle around them with the left mouse button or hold `Ctrl` to add/remove single nodes from the selection. **Pro-tip:** There is a `Select Loop` option when you right-click a node in a loop, that does exactly that for you. Then, open the context menu (right-click on a node in the selection) and select `Create Metanode`. Enter a caption for the Metanode. The previously selected nodes are now contained in the Metanode. Double-clicking on the Metanode will display the contained nodes in a new tab window.

Task

- ✓ Create the Metanode to let it behave like an encapsulated single node. First select the Metanode, open the context menu (right-click) and select `Metanode > Wrap`. The differences between Metanodes and their wrapped counterparts are marginal (and only apply when exposing user inputs and workflow variables). Therefore we suggest to use standard Metanodes to clean up your workflow and cluster common subparts until you actually notice their limits.

Task

- ✓ Undo the packaging. First select the (Wrapped) Metanode, open the context menu (right-click) and select `(Wrapped) Metanode > Expand`.

2.4.10 Advanced topic: R integration



KNIME provides a large number of nodes for a wide range of statistical analysis, machine learning, data processing, and visualization. Still, more recent statistical analysis methods, specialized visualizations or cutting edge algorithms may not be covered in KNIME. In order to expand its capabilities beyond the readily available nodes, external scripting languages can be integrated. In this tutorial, we primarily use scripts of the powerful statistical computing language R. Note that this part is considered

advanced and might be difficult to follow if you are not familiar with R. In this case you might skip this part.

R View (Table) allows to seamlessly include R scripts into KNIME. We will demonstrate on a minimal example how such a script is integrated.

Task



First we need some example data in KNIME, which we will generate using the Data Generator node. You can keep the default settings and execute the node. The table contains four columns, each containing random coordinates and one column containing a cluster number (Cluster_0 to Cluster_3). Now place a R View (Table) node into the workflow and connect the upper output port of the Data Generator node to the input of the R View (Table) node. Right-click and configure the node. If you get an error message like "Execute failed: R_HOME does not contain a folder with name 'bin'." or "Execution failed: R Home is invalid.": please change the R settings in the preferences. To do so open  and enter the path to your R installation (the folder that contains the bin directory (e.g.,  C: \>Program Files \>R \>R-3.4.3)).

If you get an error message like: "Execute failed: Could not find Rserve package. Please install it in your R installation by running "install.packages('Rserve')". You may need to run your R binary as administrator (In windows explorer: right-click "Run as administrator") and enter `install.packages('Rserve')` to install the package.

If R is correctly recognized we can start writing an R script. Consider that we are interested in plotting the first and second coordinates and color them according to their cluster number. In R this can be done in a single line. In the R View (Table) text editor, enter the following code:

```
plot(x=knime.in$Universe_0_0, y=knime.in$Universe_0_1, main="Plotting
↪ column Universe_0_0 vs. Universe_0_1", col=knime.in$"Cluster
↪ Membership")
```

Explanation: The table provided as input to the R View (Table) node is available as R data.frame with name `knime.in`. Columns (also listed on the left side of the R View window) can be accessed in the usual R way by first specifying the data.frame name and then the column name (e.g. `knime.in$Universe_0_0`). `plot` is the plotting function we use to generate the image. We tell it to use the data in column

Universe_0_0 of the dataframe object `knime.in` (denoted as `knime.in$Universe_0_0`) as x-coordinate and the other column `knime.in$Universe_0_1` as y-coordinate in the plot. `main` is simply the main title of the plot and `col` the column that is used to determine the color (in this case it is the `Cluster Membership` column).

Now press the `Eval script` and `Show plot` buttons.

Note: Note that we needed to put some extra quotes around `Cluster Membership`. If we omit those, R would interpret the column name only up to the first space (`knime.in$Cluster`) which is not present in the table and leads to an error. Quotes are regularly needed if column names contain spaces, tabs or other special characters like `$` itself.

3 Label-free quantification of peptides

3.1 Introduction

In this chapter, we will build a workflow with OpenMS / KNIME to quantify a label-free experiment. Label-free quantification is a method aiming to compare the relative amounts of proteins or peptides in two or more samples. We will start from the minimal workflow of the last chapter and, step-by-step, build a label-free quantification workflow.

3.2 Peptide Identification

As a start, we will extend the minimal workflow so that it performs a peptide identification using the OMSSA [9] search engine. Since OpenMS version 1.10, OMSSA is included in the OpenMS installation, so you do not need to download and install it yourself.

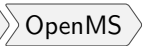
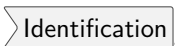
- Let's start by replacing the input files in our Input Files node by the three mzML files in `Example_Data ▶ Labelfree ▶ datasets ▶ lfq_spikein_dilution_1-3.mzML`. This is a reduced toy dataset where each of the three runs contains a constant background of *S. pyogenes* peptides as well as human spike-in peptides in different concentrations. [10]
- Instead of FileInfo, we want to perform OMSSA identification, so we simply replace the FileInfo node with the OMSSAAdapter node   , and we are almost done. Just make sure you have connected the ZipLoopStart node with the in port of the OMSSAAdapter node.
- OMSSA, like most mass spectrometry identification engines, relies on searching the input spectra against sequence databases. Thus, we need to introduce a search database input. As we want to use the same search database for all of our input files, we can just add a single Input File node to the workflow and connect it directly with the OMSSAAdapter database port. KNIME will automatically reuse this Input node each time a new ZipLoop iteration is started. In order to specify the database, select `Example_Data ▶ Labelfree ▶ databases ▶ s_pyo_sf370_potato_human_target_decoy_with_contaminants.fasta`, and we have a very basic peptide identification workflow.

Note: You might also want to save your new identification workflow under a different name. Have a look at Section 2.4.6 for information on how to create copies of workflows.

- The result of a single OMSSA run is basically a number of peptide-spectrum-matches (PSM) with a score each, and these will be stored in an idXML file. Now we can run the pipeline and after execution is finished, we can have a first look at the results: just open the input files folder with a file browser and from there open an mzML file in TOPPView.
- Here, you can annotate this spectrum data file with the peptide identification results. Choose **Tools** > **Annotate with identification** from the menu and select the idXML file that OMSSAadapter generated (it is located within the output directory that you specified when starting the pipeline).
- On the right, select the tab **Identification view**. Using this view, you can see all identified peptides and browse the corresponding MS2 spectra.

Note: Opening the output file of OMSSAadapter (the idXML file) directly is also possible, but the direct visualization of an idXML file is less useful.

- The search results stored in the idXML file can also be read back into a KNIME table for inspection and subsequent analyses: Add a TextExporter node from **Community Nodes** > **OpenMS** > **File Handling** to your workflow and connect the output port of your OMSSAadapter (the same port your ZipLoopEnd is connected to) to its input port. This tool will convert the idXML file to a more human-readable text file which can also be read into a KNIME table using the IDTextReader node. Add an IDTextReader node (**Community Nodes** > **OpenMS** > **Conversion**) after TextExporter and execute it. Now you can right-click IDTextReader and select **ID Table** to browse your peptide identifications.
- From here, you can use all the tools KNIME offers for analyzing the data in this table. As a simple example, you could add a Histogram (local) node (from category **Views - Local (Swing)**) node after IDTextReader, double-click it, select **peptide_charge** as Histogram column, hit **OK**, and execute it. Right-clicking and selecting **Interactive View: Histogram view** will open a plot showing the charge state distribution of your identifications.

In the next step, we will tweak the parameters of OMSSA to better reflect the instrument's accuracy. Also, we will extend our pipeline with a false discovery rate (FDR) filter to retain only those identifications that will yield an FDR of < 1 %.

- Open the configuration dialog of OMSSAadapter. The dataset was recorded using an LTQ Orbitrap XL mass spectrometer, so we can set the precursor mass tolerance to a smaller value, say 5 ppm. Set **precursor_mass_tolerance** to 5 and **precursor_error_units** to *ppm*.

Note: Whenever you change the configuration of a node, the node as well as all its successors will be reset to the Configured state (all node results are discarded and need to be recalculated by executing the nodes again).

- Set *max_precursor_charge* to 5, in order to also search for peptides with charges up to 5.
- Add *Carbamidomethyl (C)* as fixed modification and *Oxidation (M)* as variable modification.

Note: To add a modification click on the empty value field in the configuration dialog to open the list editor dialog. In the new dialog click . Then select the newly added modification to open the drop down list where you can select the correct modification.

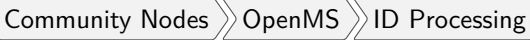
- A common step in analysis is to search not only against a regular protein database, but to also search against a decoy database for FDR estimation. The fasta file we used before already contains such a decoy database. For OpenMS to know which OMSSA PSM came from which part of the file (i.e. target versus decoy), we have to index the results. To this end, extend the workflow with a PeptideIndexer node . This node needs the idXML as input as well as the database file (see Fig 12).

Note: You can direct the files of an Input File node to more than just one destination port.

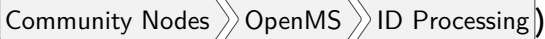
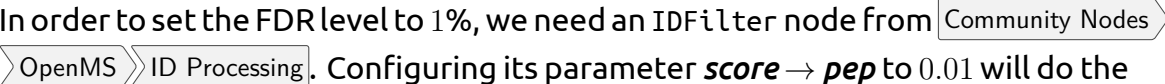
- The decoys in the database are prefixed with "DECOY_", so we have to set *decoy_string* to *DECOY_* and *decoy_string_position* to *prefix* in the configuration dialog of PeptideIndexer.
- Now we can go for the FDR estimation, which the FalseDiscoveryRate node will calculate for us (you will find it in .
- In order to set the FDR level to 1%, we need an IDFilter node from . Configuring its parameter *score* → *pep* to 0.01 will do the trick. The FDR calculations (embedded in the idXML) from the FalseDiscoveryRate node will go into the *in* port of the IDFilter node.
- Execute your workflow and inspect the results using IDTextReader like you did before. How many peptides did you identify at this FDR threshold?

Note: The finished identification workflow is now sufficiently complex that we might want to encapsulate it in a Metanode. For this, select all nodes inside the ZipLoop (including the Input File node) and right-click to select `Collapse into Metanode` and name it ID. Metanodes are useful when you construct even larger workflows and want to keep an overview.

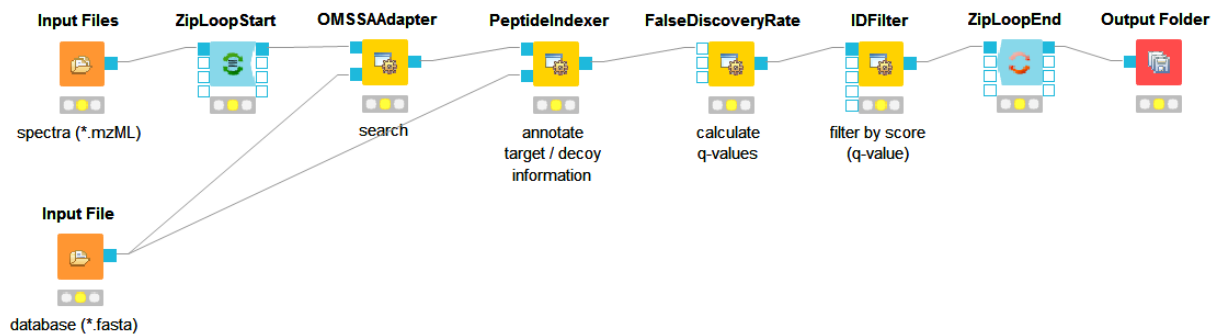

Figure 12: OMSSA ID pipeline including FDR filtering.

3.2.1 Bonus task: identification using several search engines

Note: If you are ahead of the tutorial or later on, you can further improve your FDR identification workflow by a so-called consensus identification using several search engines. Otherwise, just continue with section 3.3.

It has become widely accepted that the parallel usage of different search engines can increase peptide identification rates in shotgun proteomics experiments. The ConsensusID algorithm is based on the calculation of posterior error probabilities (PEP) and a combination of the normalized scores by considering missing peptide sequences.

- Next to the OMSSAAdapter add a XTandemAdapter `Community Nodes` `OpenMS` `Identification` node and set its parameters and ports analogously to the OMSSAAdapter. In XTandem, to get more evenly distributed scores, we decrease the number of candidates a bit by setting the precursor mass tolerance to 5 ppm and the fragment mass tolerance to 0.1 Da.
- To calculate the PEP, introduce each a IDPosteriorErrorProbability `Community Nodes` `OpenMS` `ID Processing` node to the output of each ID engine adapter node. This will calculate the PEP to each hit and output an updated idXML.

- To create a consensus, we must first merge these two files with a FileMerger node Community Nodes GenericKnimeNodes Flow so we can then merge the corresponding IDs with a IDMerger Community Nodes OpenMS File Handling.
- Now we can create a consensus identification with the ConsensusID Community Nodes OpenMS ID Processing node. We can connect this to the PeptideIndexer and go along with our existing FDR filtering.

Note: By default, X!Tandem takes additional enzyme cutting rules into consideration (besides the specified tryptic digest). Thus for the tutorial files, you have to set PeptideIndexer's *enzyme* → *specificity* parameter to none to accept X!Tandem's non-tryptic identifications as well.

In the end the ID processing part of the workflow can be collapsed into a Metanode to keep the structure clean (see Figure 13).

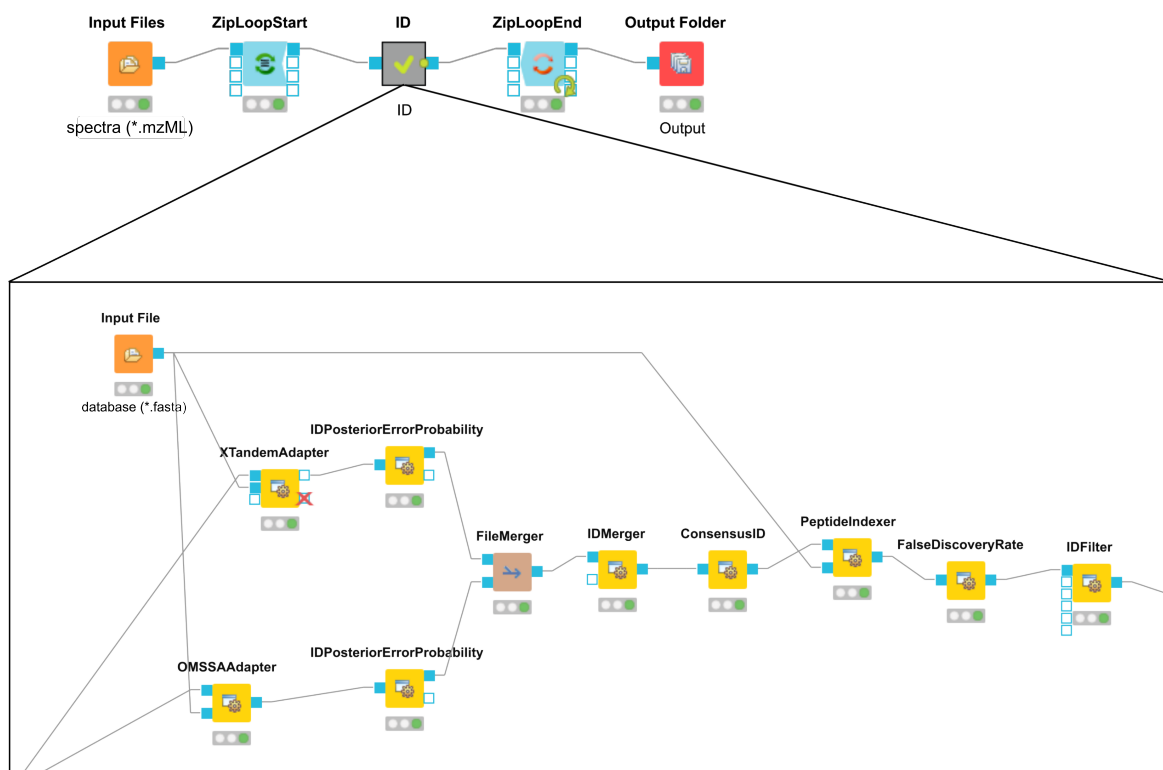

Figure 13: Complete consensus identification workflow.

3.3 Quantification

Now that we have successfully constructed a peptide identification pipeline, we can add quantification capabilities to our workflow.

- Add a FeatureFinderCentroided node from **Community Nodes >> OpenMS >> Quantitation** which gets input from the first output port of the ZipLoopStart node. Also, add an IDMapper node (from **Community Nodes >> OpenMS >> ID Processing**) which receives input from the FeatureFinderCentroided node (Port 1) and the ID Metanode (or IDFilter node (Port 0) if you haven't used the Metanode). The output of the IDMapper is then connected to an *in* port of the ZipLoopEnd node.
 - FeatureFinderCentroided finds and quantifies peptide ion signals contained in the MS1 data. It reduces the entire signal, i.e., all peaks explained by one and the same peptide ion signal, to a single peak at the maximum of the chromatographic elution profile of the monoisotopic mass trace of this peptide ion and assigns an overall intensity.
 - FeatureFinderCentroided produces a featureXML file as output, containing only quantitative information of so-far unidentified peptide signals. In order to annotate these with the corresponding ID information, we need the IDMapper node.
 - Run your pipeline and inspect the results of the IDMapper node in TOPPView. Open the mzML file of your data to display the raw peak intensities.
 - To assess how well the feature finding worked, you can project the features contained in the featureXML file on the raw data contained in the mzML file. To this end, open the featureXML file in TOPPView by clicking on **File >> Open file** and add it to a new layer (**Open in >> New layer**). The features are now visualized on top of your raw data. If you zoom in on a small region, you should be able to see the individual boxes around features that have been detected (see Fig. 14). If you hover over the the feature centroid (small circle indicating the chromatographic apex of monoisotopic trace) additional information of the feature is displayed.
- Note:** The chromatographic RT range of a feature is about 30-60 s and its m/z range around 2.5 m/z in this dataset. If you have trouble zooming in on a feature, select the full RT range and zoom only into the m/z dimension by holding down **Ctrl** (**cmd ⌘** on macOS) and repeatedly dragging a narrow box from the very left to the very right.
- You can see which features were annotated with a peptide identification by first selecting the featureXML file in the Layers window on the upper right side and

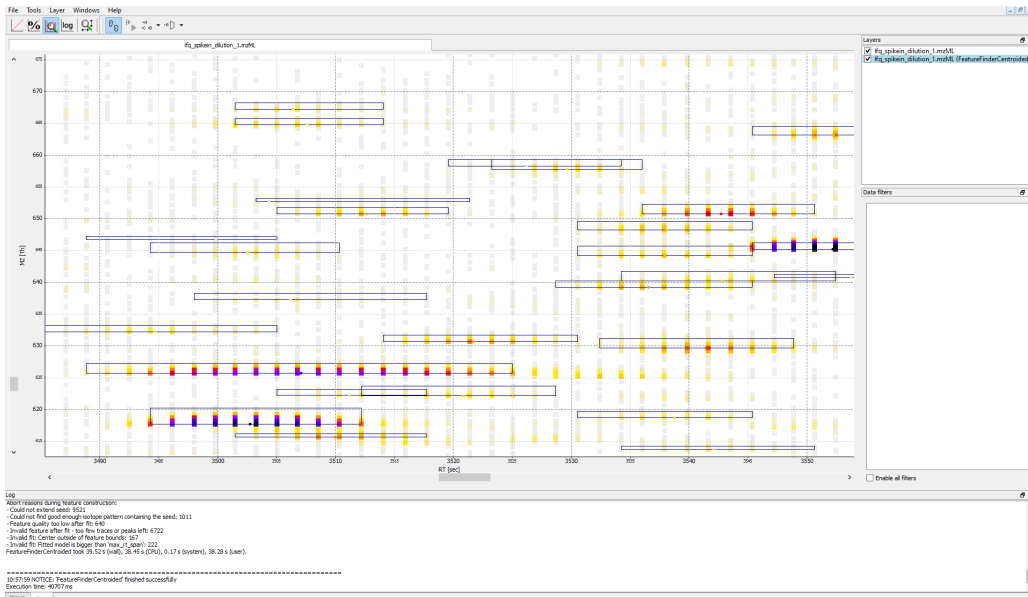

Figure 14: Visualization of detected features (boxes) in TOPPView.

then clicking on the icon with the letters A, B and C on the upper icon bar. Now, click on the small triangle next to that icon and select Peptide identification.

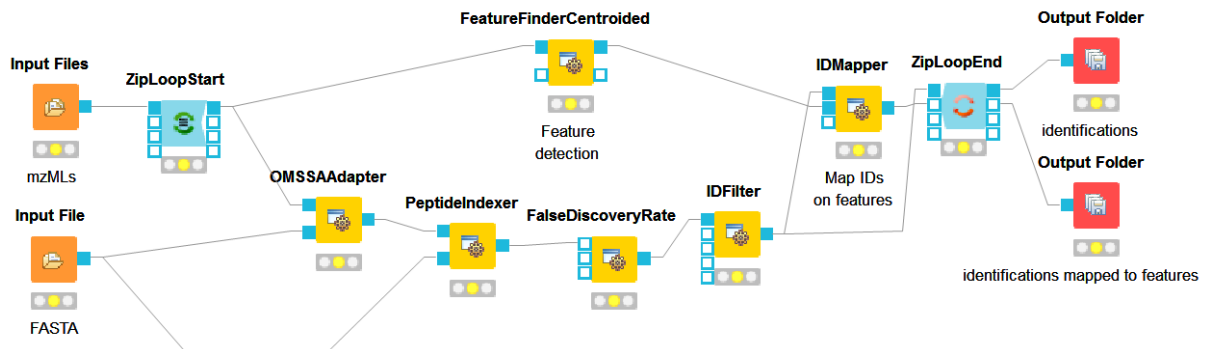

Figure 15: Extended workflow featuring peptide identification and quantification.

3.4 Combining quantitative information across several label-free experiments

So far, we successfully performed peptide identification as well as quantification on individual LC-MS runs. For differential label-free analyses, however, we need to identify and quantify corresponding signals in different experiments and link them together to compare their intensities. Thus, we will now run our pipeline on all three available input files and extend it a bit further, so that it is able to find and link features across several runs.

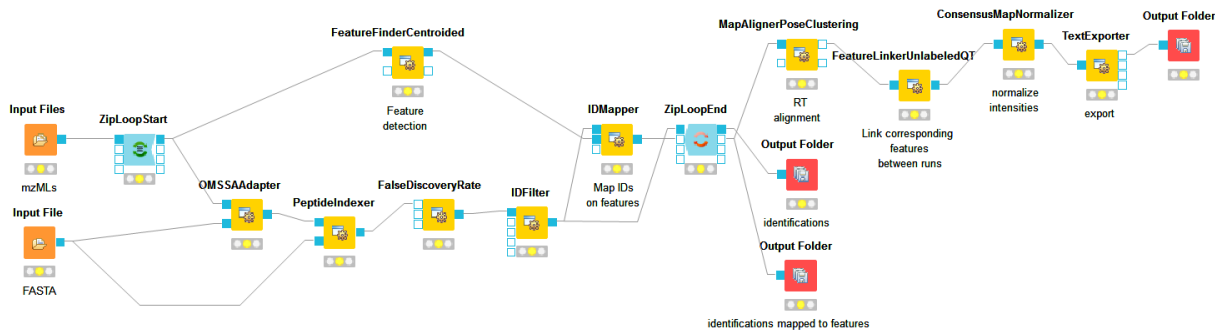

Figure 16: Complete identification and label-free quantification workflow.

- To find features across several maps, we first have to align them to correct for retention time shifts between the different label-free measurements. With the `MapAlignerPoseClustering` in `Community Nodes` `OpenMS` `Map Alignment`, we can align corresponding peptide signals to each other as closely as possible by applying a transformation in the RT dimension.

Note: `MapAlignerPoseClustering` consumes several `featureXML` files and its output should still be several `featureXML` files containing the same features, but with the transformed RT values. In its configuration dialog, make sure that ***OutputTypes*** is set to `featureXML`.

- With the `FeatureLinkerUnlabeledQT` node in `Community Nodes` `OpenMS` `Map Alignment`, we can then perform the actual linking of corresponding features. Its output is a `consensusXML` file containing linked groups of corresponding features across the different experiments.
- Since the overall intensities can vary a lot between different measurements (for example, because the amount of injected analytes was different), we apply the `ConsensusMapNormalizer` in `Community Nodes` `OpenMS` `Map Alignment` as a last processing step. Configure its parameters with setting ***algorithm_type*** to `median`. It will then normalize the maps in such a way that the median intensity of all input maps is equal.
- Finally, we export the resulting normalized `consensusXML` file to a `csv` format using `TextExporter`. Connect its out port to a new `Output Folder` node.

Note: You can specify the desired column separation character in the parameter settings (by default, it is set to " " (a space)). The output file of `TextExporter` can also be opened with external tools, e.g., Microsoft Excel, for downstream statistical analyses.

3.4.1 Basic data analysis in KNIME

For downstream analysis of the quantification results within the KNIME environment, you can use the `ConsensusTextReader` node in `Community Nodes` `OpenMS` `Conversion` instead of the `Output Folder` node to convert the output into a KNIME table (indicated by a triangle as output port). After running the node you can view the KNIME table by right-clicking on the `ConsensusTextReader` and selecting `Consensus Table`. Every row in this table corresponds to a so-called consensus feature, i.e., a peptide signal quantified across several runs. The first couple of columns describe the consensus feature as a whole (average RT and m/z across the maps, charge, etc.). The remaining columns describe the exact positions and intensities of the quantified features separately for all input samples (e.g., `intensity_0` is the intensity of the feature in the first input file). The last 11 columns contain information on peptide identification.

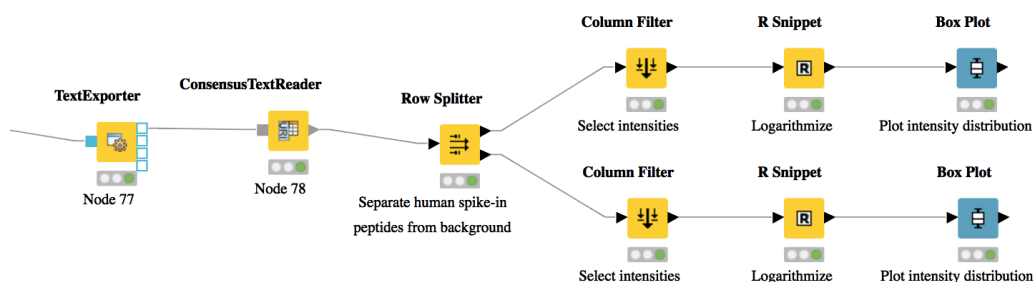

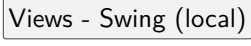

Figure 17: Simple KNIME data analysis example for LFQ.

- Now, let's say we want to plot the log intensity distributions of the human spike-in peptides for all input files. In addition, we will plot the intensity distributions of the background peptides.
- As shown in Fig. 17, add a `Row Splitter` node (`Data Manipulation` `Row` `Filter`) after `ConsensusTextReader`. Double-click it to configure. The human spike-in peptides have accessions starting with "hum". Thus, set the column to apply the test to: ***accessions***, select pattern matching as matching criterion, enter ***hum**** into the corresponding text field, and check the ***contains wild cards*** box. Press OK and execute the node.
- `Row Splitter` produces two output tables: the first one contains all rows from the input table matching the filter criterion, and the second table contains all other rows. You can inspect the tables by right-clicking and selecting ***Filtered*** and ***Filtered Out***. The former table should now only contain peptides with a

```
x <- knime.in           # store copy of input table in x
x[x == 0] <- NA        # replace all zeros by NA (= missing value)
x <- log10(x)          # compute log of all values
knime.out <- x         # write result to output table
```

human accession, whereas the latter should contain all remaining peptides (including unidentified ones).

- Now, since we only want to plot intensities, we can add a **Column Filter** node , connect its input port to the **Filtered** output port of the **Row Filter**, and open its configuration dialog. We could either manually select the columns we want to keep, or, more elegantly, select **Wildcard/Regex Selection** and enter *intensity_?* as the pattern. KNIME will interactively show you which columns your pattern applies to while you're typing.
- Since we want to plot log intensities, we will now compute the log of all intensity values in our table. The easiest way to do this in KNIME is a small piece of R code. Add an **R Snippet** node  after **Column Filter** and double-click to configure. In the **R Script** text editor, enter the following code:
- Now we are ready to plot! Add a **Box Plot (local)** node  after the **R Snippet** node, execute it, and open its view. If everything went well, you should see a significant fold change of your human peptide intensities across the three runs.
- In order to verify that the concentration of background peptides is constant in all three runs, you can just copy and paste the three nodes after **Row Splitter** and connect the duplicated **Column Filter** to the second output port (**Filtered Out**) of **Row Splitter**, as shown in Fig. 17. Execute and open the view of your second **Box Plot**.
- That's it! You have constructed an entire identification and label-free quantification workflow including a simple data analysis using KNIME!

3.5 Identification & Quantification of the iPRG2015 data with subsequent MSstats analysis

Advanced downstream data analysis of quantitative mass spectrometry-based proteomics data can be performed using MSstats [11]. This tool can be combined with an OpenMS preprocessing pipeline (e.g. in KNIME). The OpenMS experimental design is used to present the data in an MSstats-conformant way for the analysis. Here, we give an example how to utilize these resources when working with quantitative

label-free data. We describe how to use OpenMS and MSstats for the analysis of the ABRF iPRG2015 dataset [12].

Note: Reanalysing the full dataset from scratch would take too long. In this tutorial session, we will focus on just the conversion process and the downstream analysis.

3.5.1 Excursion MSstats

The R package MSstats can be used for statistical relative quantification of proteins and peptides in mass spectrometry-based proteomics. Supported are label-free as well as labeled experiments in combination with data-dependent, targeted and data-independent acquisition. Inputs can be identified and quantified entities (peptides or proteins) and the output is a list of differentially abundant entities, or summaries of their relative abundance. It depends on accurate feature detection, identification and quantification which can be performed e.g. by an OpenMS workflow.

In general MSstats can be used for data processing & visualization, as well as statistical modeling & inference. Please see [11] and <http://msstats.org> for further information.

3.5.2 Dataset

The iPRG (Proteome Informatics Research Group) dataset from the study in 2015, as described in [12], aims at evaluating the effect of statistical analysis software on the accuracy of results on a proteomics label-free quantification experiment. The data is based on four artificial samples with known composition (background: 200 ng *S. cerevisiae*). These were spiked with different quantities of individual digested proteins, whose identifiers were masked for the competition as yeast proteins in the provided database (see Table 1).

Table 1: Samples (background: 200 ng *S. cerevisiae*) with spiked-in proteins in different quantities [fmols].

	Name	Origin	Molecular Weight	Samples			
				1	2	3	4
A	Ovalbumin	<i>Egg White</i>	45 KD	65	55	15	2
B	Myoglobin	<i>Equine Heart</i>	17 KD	55	15	2	65
C	Phosphorylase b	<i>Rabbit Muscle</i>	97 KD	15	2	65	55
D	Beta-Glactosidase	<i>Escherichia Coli</i>	116 KD	2	65	55	15
E	Bovine Serum Albumin	<i>Bovine Serum</i>	66 KD	11	0.6	10	500
F	Carbonic Anhydrase	<i>Bovine Erythrocytes</i>	29 KD	10	500	11	0.6

3.5.3 Identification and Quantification

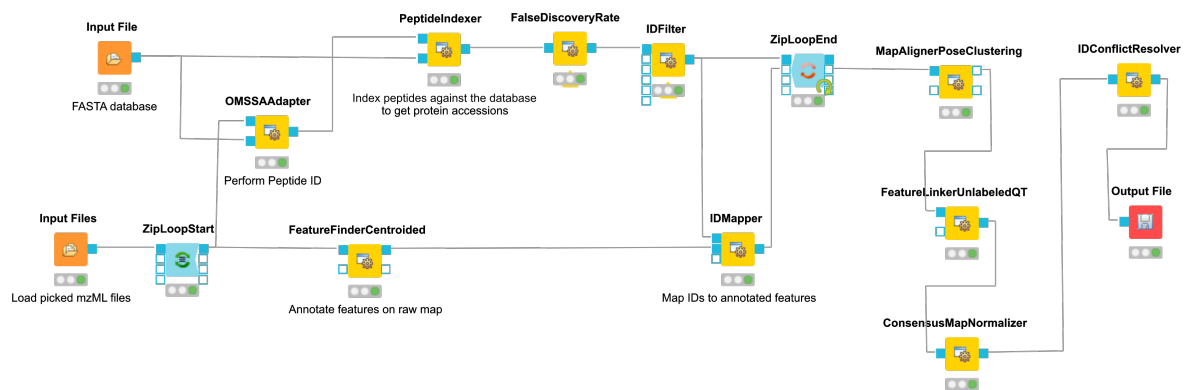

Figure 18: KNIME data analysis of iPRG LFQ data.

The iPRG LFQ workflow (Fig. 18) consists of an identification and a quantification part. The identification is achieved by searching the computationally calculated MS2 spectra from a sequence database (Input File node, here with the given database from iPRG: `Example_Data\iPRG2015\database\iPRG2015_target_decoy_nocontaminants.fasta`) against the MS2 from the original data (Input Files node with all mzMLs following `Example_Data\iPRG2015\datasets\JD_06232014_sample*.mzML`) using the OMSSAAdapter.

Note: If you want to reproduce the results at home, you have to download the iPRG data in mzML format and perform Peakpicking on it. Or convert and pick the raw data with msconvert.

Afterwards the results are scored using the FalseDiscoveryRate node and filtered to obtain only unique peptides (IDFilter) since MSstats does not support shared peptides, yet. The quantification is achieved by the FeatureFinderCentroided, which performs the feature detection on the samples (maps). In the end the quantification results are combined with the filtered identification results (IDMapper). In addition, a linear retention time alignment is performed (MapAlignerPoseClustering), followed by the feature linking process (FeatureLinkerUnlabeledQT). The ConsensusMapNormalizer is used to normalize the intensities via robust regression over a set of maps and the IDConflictResolver assures that only one identification (best score) is associated with a feature. The output of this workflow is a consensusXML file, which can now be converted using the MSstatsConverter (see section 3.5.5).

3.5.4 Experimental design

As mentioned before, the downstream analysis can be performed using MSstats. In this case an experimental design has to be specified for the OpenMS workflow. The

structure of the experimental design used in OpenMS in case of the iPRG dataset is specified in Table 2. An explanation of the variables can be found in Table 3.

Table 2: OpenMS Experimental design for the iPRG2015 dataset.

Fraction_Group	Fraction	Spectra_Filepath	Label	Sample
1	1	Sample1-A	1	1
2	1	Sample1-B	1	2
3	1	Sample1-C	1	3
4	1	Sample2-A	1	4
5	1	Sample2-B	1	5
6	1	Sample2-C	1	6
7	1	Sample3-A	1	7
8	1	Sample3-B	1	8
9	1	Sample3-C	1	9
10	1	Sample4-A	1	10
11	1	Sample4-B	1	11
12	1	Sample4-C	1	12

Sample	MSstats_Condition	MSstats_BioReplicate
1	1	1
2	1	2
3	1	3
4	2	4
5	2	5
6	2	6
7	3	7
8	3	8
9	3	9
10	4	10
11	4	11
12	4	12

Table 3: Explanation of the column of the experimental design table

variables	value
<i>Fraction_Group</i>	Index used to group fractions and source files.
<i>Fraction</i>	1st, 2nd, .., fraction. Note: All runs must have the same number of fractions.
<i>Spectra_Filepath</i>	Path to mzML files
<i>Label</i>	label-free: always 1 TMT6Plex: 1..6 SILAC with light and heavy: 1..2
<i>Sample</i>	Index of sample measured in the specified label X, in fraction Y of fraction group Z.
<i>Conditions</i>	Further specification of different conditions (e.g. MSstats_Condition; MSstats_BioReplicate)

The conditions are highly dependent on the type of experiment and on which kind of

analysis you want to perform. For the MSstats analysis the information which sample belongs to which condition and if there are biological replicates are mandatory. This can be specified in further condition columns as explained in Table 3. For a detailed description of the MSstats-specific terminology, see their documentation e.g. in the R vignette.

3.5.5 Conversion and downstream analysis

Conversion of the OpenMS-internal consensusXML format (which is an aggregation of quantified and possibly identified features across several MS-maps) to a table (in MSstats-conformant CSV format) is very easy. First, create a new KNIME workflow. Then, run the MSstatsConverter node with a consensusXML and the manually created (e.g. in Excel) experimental design as inputs (loaded via Input File nodes). The first input can be found in

Example_Data ▶ iPRG2015 ▶ openmsLFQResults ▶ iPRG_lfq.consensusXML

This file was generated by using the Workflows ▶ openmsLFQ_iPRG2015.knwf workflow (seen in Fig. 18). The second input is specified in

Example_Data ▶ iPRG2015 ▶ experimental_design.tsv.

Adjust the parameters in the config dialog of the converter to match the given experimental design file and to use a simple summing for peptides that elute in multiple features (with the same charge state, i.e. m/z value).

parameter	value
<i>msstats_bioreplicate</i>	MSstats_Bioreplicate
<i>msstats_condition</i>	MSstats_Condition
<i>labeled_reference_peptides</i>	false
<i>retention_time_summarization_method (advanced)</i>	sum

The downstream analysis of the peptide ions with MSstats is performed in several steps. These steps are reflected by several KNIME R nodes, which consume the output of MSstatsConverter. The outline of the workflow is shown in Figure 19.

We load the file resulting from MSstatsConverter either by saving it with an Output File node and reloading it with the File Reader. Or for advanced users, you can use a URI Port to Variable node and use the variable in the File Reader config dialog (V button - located on the right of the "Browse..." button) to read from the temporary file.

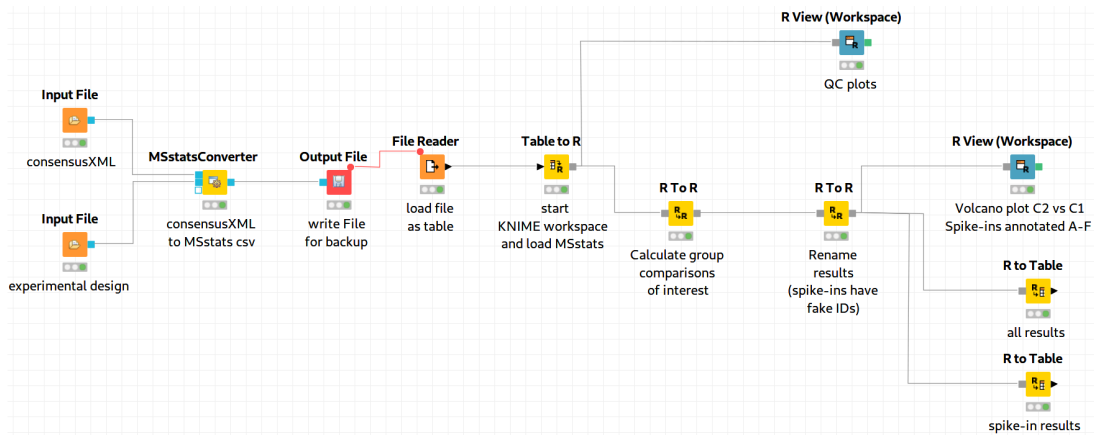

Figure 19: MSstats analysis using KNIME. The individual steps (Preprocessing, Group Comparisons, Result Data Renaming, and Export) are split among several consecutive nodes.

```
library(MSstats)
data <- knime.in
quant <- OpenMStoMSstatsFormat(data, removeProtein_with1Feature = FALSE)
```

Preprocessing

The first node (Table to R) loads MSstats as well as the data from the previous KNIME node and performs a preprocessing step on the input data. The inline R script (that needs to be pasted into the config dialog of the node) allows further preparation of the data produced by MSstatsConverter before the actual analysis is performed. In this example, the lines with proteins, which were identified with only one feature, were retained. Alternatively they could be removed.

In the same node, most importantly, the following line: transforms the data into a format that is understood by MSstats. Here, dataProcess is one of the most important functions that the R package provides. The function performs the following steps:

1. Logarithm transformation of the intensities
2. Normalization
3. Feature selection
4. Missing value imputation
5. Run-level summarization

In this example, we just state that missing intensity values are represented by the 'NA' string.

```
processed.quant <- dataProcess(quant, censoredInt = 'NA')
```



```

comparison1<-matrix(c(-1,1,0,0),nrow=1)
comparison2<-matrix(c(-1,0,1,0),nrow=1)
comparison3<-matrix(c(-1,0,0,1),nrow=1)
comparison4<-matrix(c(0,-1,1,0),nrow=1)
comparison5<-matrix(c(0,-1,0,1),nrow=1)
comparison6<-matrix(c(0,0,-1,1),nrow=1)
comparison <- rbind(comparison1, comparison2, comparison3, comparison4,
  ↪ comparison5, comparison6)
row.names(comparison)<-c("C2-C1","C3-C1","C4-C1","C3-C2","C4-C2","C4-C3")

```

```

test.MSstats <- groupComparison(contrast.matrix=comparison, data=processed.quant)
}

```

Group Comparison

The goal of the analysis is the determination of differentially-expressed proteins among the different conditions C1-C4. We can specify the comparisons that we want to make in a *comparison matrix*. For this, let's consider the following example:

$$\begin{pmatrix} -1 & 1 & 0 & 0 \\ -1 & 0 & 1 & 0 \\ -1 & 0 & 0 & 1 \\ 0 & -1 & 0 & 1 \\ 0 & 0 & -1 & 1 \end{pmatrix} \quad (3.1)$$

This matrix has the following properties:

- The number of rows equals the number of comparisons that we want to perform, the number of columns equals the number of conditions (here, column 1 refers to C1, column 2 to C2 and so forth).
- The entries of each row consist of exactly one 1 and one -1, the others must be 0.
- The condition with the entry 1 constitutes the numerator of the log₂ fold-change. The one with entry -1 denotes the denominator. Hence, the first row states that we want calculate $\log \frac{C_2}{C_1}$.

We can generate such a matrix in R using the following code snippet in (for example) a new R to R node that takes over the R workspace from the previous node with all its variables: Here, we assemble each row in turn, concatenate them at the end, and provide row names for labeling the rows with the respective condition.

In MSstats, the group comparison is then performed with the following line: No more parameters need to be set for performing the comparison.

```

test.MSstats.cr <- test.MSstats$ComparisonResult

# Rename spiked ins to A,B,C...
pnames <- c("A", "B", "C", "D", "E", "F")
names(pnames) <- c(
  "sp|P44015|VAC2_YEAST",
  "sp|P55752|ISCB_YEAST",
  "sp|P44374|SFG2_YEAST",
  "sp|P44983|UTR6_YEAST",
  "sp|P44683|PGA4_YEAST",
  "sp|P55249|ZRT4_YEAST"
)

test.MSstats.cr.spikedins <- bind_rows(
  test.MSstats.cr[grep("P44015", test.MSstats.cr$Protein),],
  test.MSstats.cr[grep("P55752", test.MSstats.cr$Protein),],
  test.MSstats.cr[grep("P44374", test.MSstats.cr$Protein),],
  test.MSstats.cr[grep("P44683", test.MSstats.cr$Protein),],
  test.MSstats.cr[grep("P44983", test.MSstats.cr$Protein),],
  test.MSstats.cr[grep("P55249", test.MSstats.cr$Protein),]
)
# Rename Proteins
test.MSstats.cr.spikedins$Protein <- sapply(test.MSstats.cr.spikedins$Protein,
  ↪ function(x) {pnames[as.character(x)]})
test.MSstats.cr$Protein <- sapply(test.MSstats.cr$Protein, function(x) {
  x <- as.character(x)

  if (x %in% names(pnames)) {
    return(pnames[as.character(x)])
  } else {
    return("")
  }
})

```

```

qcplot <- dataProcessPlots(processed.quant, type="QCplot",
  ylimDown=0,
  which.Protein = 'allonly',
  width=7, height=7, address=F)

```

Result Processing

In a next R to R node, the results are being processed. The following code snippet: will rename the spiked-in proteins to A,B,C,D,E, and F and remove the names of other proteins, which will be beneficial for the subsequent visualization, as for example performed in Figure 20.

Export

The last four nodes, each connected and making use of the same workspace from the last node, will export the results to a textual representation and volcano plots for further inspection. Firstly, quality control can be performed with the following snippet: The code for this snippet is embedded in the first output node of the workflow. The resulting boxplots show the log₂ intensity distribution across the MS runs.

The second node is an R View (Workspace) node that returns a Volcano plot which displays differentially expressed proteins between conditions C2 vs. C1. The plot is

```
groupComparisonPlots(data=test.MSstats.cr, type="VolcanoPlot",  
  width=12, height=12, dot.size = 2, ylimUp = 7,  
  which.Comparison = "C2-C1",  
  address=F)
```

```
knime.out <- test.MSstats.cr
```

described in more detail in the following Result section. This is how you generate it: The last two nodes export the MSstats results as a KNIME table for potential further analysis or for writing it to a (e.g. csv) file. Note that you could also write output inside the Rscript if you are familiar with it. Use the following for an R to Table node exporting all results: And this for an R to Table node exporting only results for the spike-ins:

3.5.6 Result

An excerpt of the main result of the group comparison can be seen in Figure 20. The Volcano plots show differently expressed spiked-in proteins. In the left plot, which shows the fold-change C2-C1, we can see the proteins D and F (sp|P44983|UTR6_YEAST and sp|P55249|ZRT4_YEAST) are significantly over-expressed in C2, while the proteins B,C, and E (sp|P55752|ISCB_YEAST, sp|P55752|ISCB_YEAST, and sp|P44683|PGA4_YEAST) are under-expressed. In the right plot, which shows the fold-change ratio of C3 vs. C2, we can see the proteins E and C (sp|P44683|PGA4_YEAST and sp|P44374|SFG2_YEAST) over-expressed and the proteins A and F (sp|P44015|VAC2_YEAST and sp|P55249|ZRT4_YEAST) under-expressed. The plots also show further differentially-expressed proteins, which do not belong to the spiked-in proteins.

The full analysis workflow can be found under

📁 Workflows ▶ MSstats_statPostProcessing_iPRG2015.knwf.

```
knime.out <- test.MSstats.cr.spikedins
```

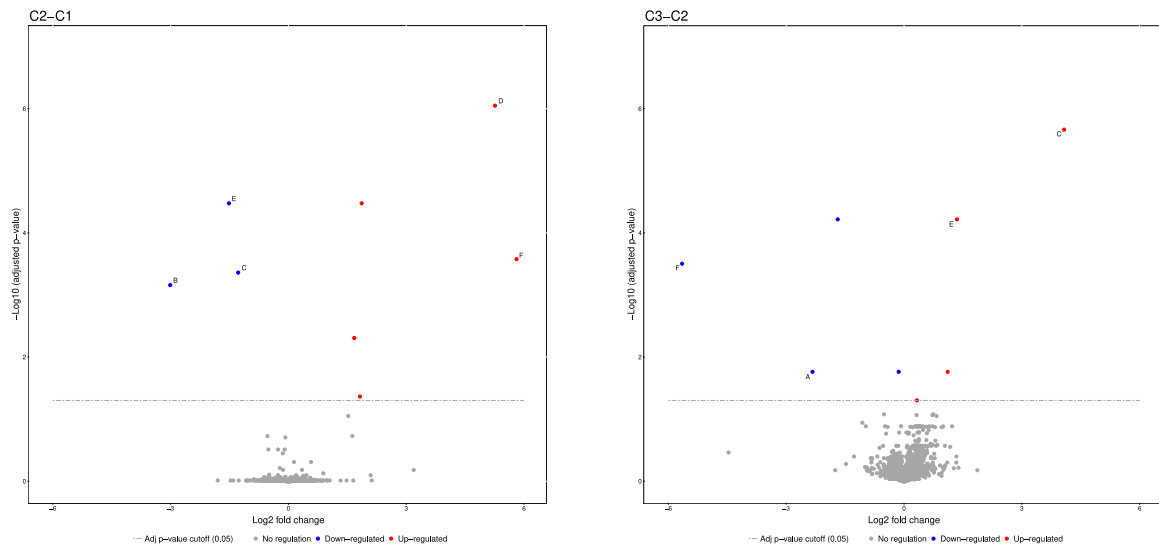

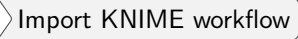



Figure 20: Volcano plots produced by the Group Comparison in MSstats. The dotted line indicates an adjusted p-value threshold.

4 Protein Inference

In the last chapter, we have successfully quantified peptides in a label-free experiment. As a next step, we will further extend this label-free quantification workflow by protein inference and protein quantification capabilities. This workflow uses some of the more advanced concepts of KNIME, as well as a few more nodes containing R code. For these reasons, you will not have to build it yourself. Instead, we have already prepared and copied this workflow to the USB sticks. Just import  Workflows > `labelfree_with_protein_quantification.knwf` into KNIME via the menu entry    and double-click the imported workflow in order to open it.

Before you can execute the workflow, you again have to correct the locations of the files in the Input Files nodes (don't forget the one for the FASTA database inside the "ID" meta node). Try and run your workflow by executing all nodes at once.

4.1 Extending the LFQ workflow by protein inference and quantification

We have made the following changes compared to the original label-free quantification workflow from the last chapter:

- First, we have added a ProteinQuantifier node and connected its input port to the output port of ConsensusMapNormalizer.
- This already enables protein quantification. ProteinQuantifier quantifies peptides by summarizing over all observed charge states and proteins by summarizing over their quantified peptides. It stores two output files, one for the quantified peptides and one for the proteins.
- In this example, we consider only the protein quantification output file, which is written to the first output port of ProteinQuantifier
- Because there is no dedicated node in KNIME to read back the ProteinQuantifier output file format into a KNIME table, we have to use a workaround. Here, we have added an additional URI Port to Variable node which converts the name of the output file to a so-called "flow variable" in KNIME. This variable is passed on to the next node CSV Reader, where it is used to specify the name of the input file to be read. If you double-click on CSV Reader, you will see that the text field, where you usually enter the location of the CSV file to be read, is greyed out. Instead, the flow variable is used to specify the location, as indicated by the small green button with the "v=?" label on the right.

- The table containing the ProteinQuantifier results is filtered one more time in order to remove decoy proteins. You can have a look at the final list of quantified protein groups by right-clicking the Row Filter and selecting Filtered.
- By default, i.e., when the second input port *protein_groups* is not used, ProteinQuantifier quantifies proteins using only the unique peptides, which usually results in rather low numbers of quantified proteins.
- In this example, however, we have performed protein inference using Fido and used the resulting protein grouping information to also quantify indistinguishable proteins. In fact, we also used a greedy method in FidoAdapter (parameter *greedy_group_resolution*) to uniquely assign the peptides of a group to the most probable protein(s) in the respective group. This boosts the number of quantifications but slightly raises the chances to yield distorted protein quantities.
- As a prerequisite for using FidoAdapter, we have added an IDPosteriorErrorProbability node within the ID meta node, between the XTandemAdapter (note the replacement of OMSSA because of ill-calibrated scores) and PeptideIndexer. We have set its parameter *prob_correct* to *true*, so it computes posterior probabilities instead of posterior error probabilities (1 - PEP). These are stored in the resulting idXML file and later on used by the Fido algorithm. Also note that we excluded FDR filtering from the standard meta node. Harsh filtering before inference impacts the calibration of the results. Since we filter peptides before quantification though, no potentially random peptides will be included in the results anyway.
- Next, we have added a third outgoing connection to our ID meta node and connected it to the second input port of ZipLoopEnd. Thus, KNIME will wait until all input files have been processed by the loop and then pass on the resulting list of idXML files to the subsequent IDMerger node, which merges all identifications from all idXML files into a single idXML file. This is done to get a unique assignment of peptides to proteins over all samples.
- Instead of the meta node Protein inference with FidoAdapter, we could have just used a FidoAdapter node (Community Nodes OpenMS ID Processing). However, the meta node contains an additional subworkflow which, besides calling FidoAdapter, performs a statistical validation (e.g. (pseudo) receiver operating curves; ROCs) of the protein inference results using some of the more advanced KNIME and R nodes. The meta node also shows how to use MzTabExporter and MzTabReader.

4.2 Statistical validation of protein inference results

In the following, we will explain the subworkflow contained in the Protein Inference with FidoAdapter meta node.

4.2.1 Data preparation

For downstream analysis on the protein ID level in KNIME, it is again necessary to convert the idXML-file-format result generated from FidoAdapter into a KNIME table.

- We use the MzTabExporter to convert the inference results from FidoAdapter to a human readable, tab-separated mzTab file. mzTab contains multiple sections, that are all exported by default, if applicable. This file, with its different sections can again be read by the MzTabReader that produces one output in KNIME table format (triangle ports) for each section. Some ports might be empty if a section did not exist. Of course, we continue by connecting the downstream nodes with the protein section output (second port).
- Since the protein section contains single proteins as well as protein groups, we filter them for single proteins with the standard Row Filter.

4.2.2 ROC curve of protein ID

ROC Curves (Receiver Operating Characteristic curves) are graphical plots that visualize sensitivity (true-positive rate) against fall-out (false positive rate). They are often used to judge the quality of a discrimination method like e.g., peptide or protein identification engines. ROC Curve already provides the functionality of drawing ROC curves for binary classification problems. When configuring this node, select the *opt_global_target_decoy* column as the class (i.e. target outcome) column. We want to find out, how good our inferred protein probability discriminates between them, therefore add

best_search_engine_score[1] (the inference engine score is treated like a peptide search engine score) to the list of ***Columns containing positive class probabilities***. View the plot by right-clicking and selecting View: ROC Curves. A perfect classifier has an area under the curve (AUC) of 1.0 and its curve touches the upper left of the plot. However, in protein or peptide identification, the ground-truth (i.e., which target identifications are true, which are false) is usually not known. Instead, so called pseudo-ROC Curves are regularly used to plot the number of target proteins against the false discovery rate (FDR) or its protein-centric counterpart, the q-value. The FDR is approximated by using the target-decoy estimate in order to distinguish true IDs from false IDs by separating target IDs from decoy IDs.

4.2.3 Posterior probability and FDR of protein IDs

ROC curves illustrate the discriminative capability of the scores of IDs. In the case of protein identifications, Fido produces the posterior probability of each protein as the output score. However, a perfect score should not only be highly discriminative (distinguishing true from false IDs), it should also be “calibrated” (for probability indicating that all IDs with reported posterior probability scores of 95% should roughly have a 5% probability of being false. This implies that the estimated number of false positives can be computed as the sum of posterior error probabilities ($= 1 - \text{posterior probability}$) in a set, divided by the number of proteins in the set. Thereby a posterior-probability-estimated FDR is computed which can be compared to the actual target-decoy FDR. We can plot calibration curves to help us visualize the quality of the score (when the score is interpreted as a probability as Fido does), by comparing how similar the target-decoy estimated FDR and the posterior probability estimated FDR are. Good results should show a close correspondence between these two measurements, although a non-correspondence does not necessarily indicate wrong results.

The calculation is done by using a simple R script in R snippet. First, the target decoy protein FDR is computed as the proportion of decoy proteins among all significant protein IDs. Then posterior probabilistic-driven FDR is estimated by the average of the posterior error probability of all significant protein IDs. Since FDR is the property for a group of protein IDs, we can also calculate a local property for each protein: the q -value of a certain protein ID is the minimum FDR of any groups of protein IDs that contain this protein ID. We plot the protein ID results versus two different kinds of FDR estimates in R `View(Table)` (see Fig. 22).

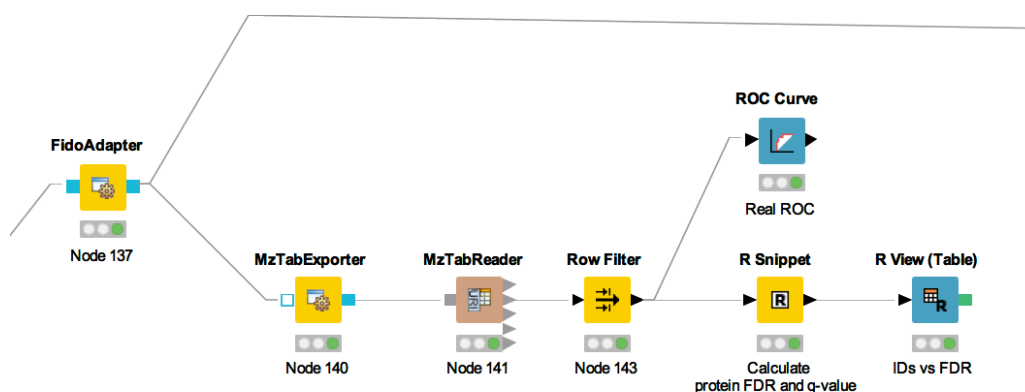

Figure 21: The workflow of statistical analysis of protein inference results

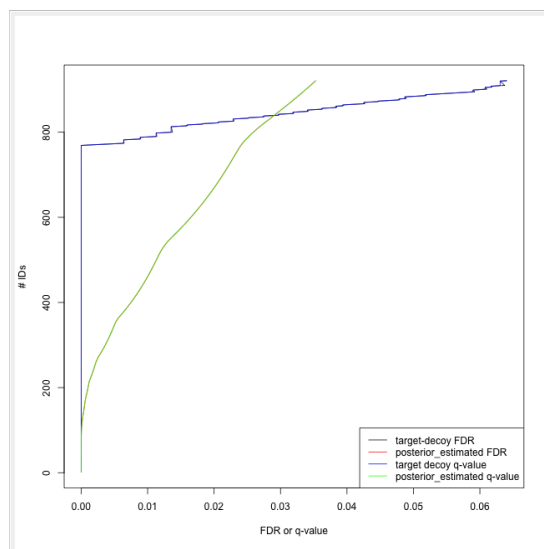

Figure 22: the pseudo-ROC Curve of protein IDs. The accumulated number of protein IDs is plotted on two kinds of scales: target-decoy protein FDR and Fido posterior probability estimated FDR. The largest value of posterior probability estimated FDR is already smaller than 0.04, this is because the posterior probability output from Fido is generally very high.

5 Isobaric analysis

In the last chapters, we identified and quantified peptides in a label-free experiment. In this section, we would like to introduce a possible workflow for the analysis of isobaric data.

5.1 Isobaric analysis workflow

Let's have a look at the workflow (see Fig 23)

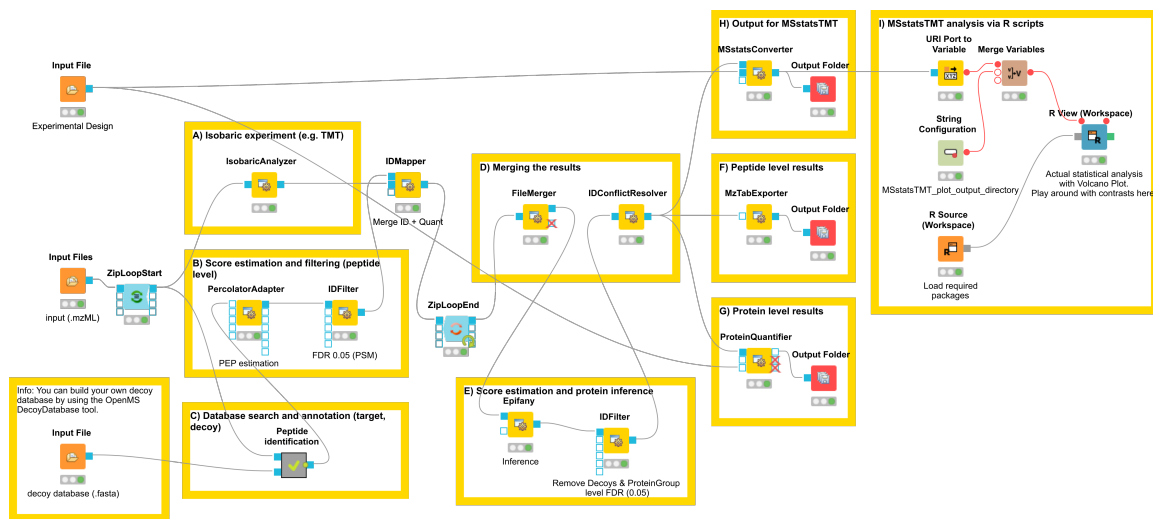

Figure 23: Workflow for the analysis of isobaric data

The full analysis workflow can be found here:

[Workflows](#) ▶



Identification_quantification_isobaric_inference_epifany_MSstatsTMT.

The workflow has four input nodes. The first for the experimental design to allow for MSstatsTMT compatible export (MSstatsConverter). The second for the .mzML files with the centroided MS2 or MS3 spectra from the isobaric labeling experiment and the third one for the .fasta database used for identification. The last one allows to specify an output path for the plots generated by the R View, which runs MSstatsTMT (I). The quantification (A) is performed using the IsobaricAnalyzer. The tool is able to extract and normalize quantitative information from TMT and iTRAQ data. The values can be assessed from centroided MS2 or MS3 spectra (if available). Isotope correction is performed based on the specified correction matrix (as provided by the manufacturer). The identification (C) is applied as known from the previous chapters by using database search and a target-decoy database.

To reduce the complexity of the data for later inference the q-value estimation and FDR filtering is performed on PSM level for each file individually (B). Afterwards the

identification (PSM) and quantitative information is combined using the IDMapper. After the processing of all available files, the intermediate results are aggregated (FileMerger - D). All PSM results are used for score estimation and protein inference (Epifany) (E). For detailed information about protein inference please see Chapter 4. Then, decoys are removed and the inference results are filtered via a protein group FDR. Peptide level results can be exported via MzTabExporter (F), protein level results can be obtained via the ProteinQuantifier (G) or the results can be exported (MSstatsConverter - H) and further processed with the following R pipeline to allow for downstream processing using MSstatsTMT.

Please import the workflow from  Workflows >

Identification_quantification_isobaric_inference_epifany_MSstatsTMT into KNIME via the menu entry  File >>  Import KNIME workflow >>  Select file and double-click the imported workflow in order to open it. Before you can execute the workflow, you have to correct the locations of the files in the Input Files nodes (don't forget the one for the FASTA database inside the "ID" meta node). Try and run your workflow by executing all nodes at once.

5.2 Excursion MSstatsTMT

The R package MSstatsTMT can be used for protein significance analysis in shotgun mass spectrometry-based proteomic experiments with tandem mass tag (TMT) labeling. MSstatsTMT provides functionality for two types of analysis & their visualization: Protein summarization based on peptide quantification and Model-based group comparison to detect significant changes in abundance. It depends on accurate feature detection, identification and quantification which can be performed e.g. by an OpenMS workflow.

In general MSstatsTMT can be used for data processing & visualization, as well as statistical modeling. Please see [13] and <http://msstats.org/msstatstmt/> for further information.

There is also a very helpful online lecture and tutorial for MSstatsTMT from the May Institute Workshop 2020. Please see <https://youtu.be/3CDnrQxGLbA>

5.3 Dataset & Experimental Design

We are using the MSV000084264 ground truth dataset, which consists of TMT10plex controlled mixes of different concentrated UPS1 peptides spiked into SILAC HeLa

peptides measured in a dilution series <https://www.omicsdi.org/dataset/massive/MSV000084264>. Figure 24 shows the experimental design. In this experiment 5 different TMT10plex mixtures – different labeling strategies – were analysed. These were measured in triplicates represented by the 15 MS runs (3 runs each). The example data, database and experimental design to run the workflow can be found here https://abibuilder.informatik.uni-tuebingen.de/archive/openms/Tutorials/Data/isobaric_MSV000084264/.

TMT10plex reagent		126	127N	127C	128N	128C	129N	129C	130N	130C	131
Mixture 1	Run 1	Ref	0.667	0.125	0.5	1	0.125	0.5	1	0.667	Ref
	Run 2	Ref	0.667	0.125	0.5	1	0.125	0.5	1	0.667	Ref
	Run 3	Ref	0.667	0.125	0.5	1	0.125	0.5	1	0.667	Ref
Mixture 2	Run 4	Ref	0.5	1	0.667	0.125	1	0.667	0.125	0.5	Ref
	Run 5	Ref	0.5	1	0.667	0.125	1	0.667	0.125	0.5	Ref
	Run 6	Ref	0.5	1	0.667	0.125	1	0.667	0.125	0.5	Ref
Mixture 3	Run 7	Ref	0.125	0.667	1	0.5	0.5	0.125	0.667	1	Ref
	Run 8	Ref	0.125	0.667	1	0.5	0.5	0.125	0.667	1	Ref
	Run 9	Ref	0.125	0.667	1	0.5	0.5	0.125	0.667	1	Ref
Mixture 4	Run 10	Ref	1	0.5	0.125	0.667	0.667	1	0.5	0.125	Ref
	Run 11	Ref	1	0.5	0.125	0.667	0.667	1	0.5	0.125	Ref
	Run 12	Ref	1	0.5	0.125	0.667	0.667	1	0.5	0.125	Ref
Mixture 5	Run 13	Ref	0.667	0.125	0.5	1	0.125	0.5	1	0.667	Ref
	Run 14	Ref	0.667	0.125	0.5	1	0.125	0.5	1	0.667	Ref
	Run 15	Ref	0.667	0.125	0.5	1	0.125	0.5	1	0.667	Ref

Figure 24: Experimental Design

The experimental design in table format allows for MSstatsTMT compatible export. The design is represented by two tables. The first one 4 represents the overall structure of the experiment in terms of samples, fractions, labels and fraction groups. The second one 5 adds to the first by specifying specific conditions, biological replicates as well as mixtures and label for each channel. For additional information about the experimental design please see Table 3 in Chapter 3.5.4.

After running the workflow the MSstatsConverter will convert the OpenMS output in addition with the experimental design to a file (.csv) which can be processed by using MSstatsTMT.

5.3.1 MSstatsTMT analysis

Here, we depict the analysis by MSstatsTMT using a segment of the isobaric analysis workflow (Fig. 25). The segment is available as  Workflows ▶ MSstatsTMT.knwf.

There are two input nodes, the first one takes the result (.csv) from the MSstatsConverter

Table 4: Experimental Design 1

Spectra_Filepath	Fraction	Label	Fraction_Group	Sample
161117_SILAC_HeLa_UPS1_TMT10_SPS_MS3_Mixture1_01.mzML	1	1	1	1
161117_SILAC_HeLa_UPS1_TMT10_SPS_MS3_Mixture1_01.mzML	1	2	1	2
161117_SILAC_HeLa_UPS1_TMT10_SPS_MS3_Mixture1_01.mzML	1	3	1	3
161117_SILAC_HeLa_UPS1_TMT10_SPS_MS3_Mixture1_01.mzML	1	4	1	4
161117_SILAC_HeLa_UPS1_TMT10_SPS_MS3_Mixture1_01.mzML	1	5	1	5
161117_SILAC_HeLa_UPS1_TMT10_SPS_MS3_Mixture1_01.mzML	1	6	1	6
161117_SILAC_HeLa_UPS1_TMT10_SPS_MS3_Mixture1_01.mzML	1	7	1	7
161117_SILAC_HeLa_UPS1_TMT10_SPS_MS3_Mixture1_01.mzML	1	8	1	8
161117_SILAC_HeLa_UPS1_TMT10_SPS_MS3_Mixture1_01.mzML	1	9	1	9
161117_SILAC_HeLa_UPS1_TMT10_SPS_MS3_Mixture1_01.mzML	1	10	1	10
161117_SILAC_HeLa_UPS1_TMT10_SPS_MS3_Mixture1_02.mzML	1	1	2	11
161117_SILAC_HeLa_UPS1_TMT10_SPS_MS3_Mixture1_02.mzML	1	2	2	12
161117_SILAC_HeLa_UPS1_TMT10_SPS_MS3_Mixture1_02.mzML	1	3	2	13
161117_SILAC_HeLa_UPS1_TMT10_SPS_MS3_Mixture1_02.mzML	1	4	2	14
161117_SILAC_HeLa_UPS1_TMT10_SPS_MS3_Mixture1_02.mzML	1	5	2	15
161117_SILAC_HeLa_UPS1_TMT10_SPS_MS3_Mixture1_02.mzML	1	6	2	16
161117_SILAC_HeLa_UPS1_TMT10_SPS_MS3_Mixture1_02.mzML	1	7	2	17
161117_SILAC_HeLa_UPS1_TMT10_SPS_MS3_Mixture1_02.mzML	1	8	2	18
161117_SILAC_HeLa_UPS1_TMT10_SPS_MS3_Mixture1_02.mzML	1	9	2	19
161117_SILAC_HeLa_UPS1_TMT10_SPS_MS3_Mixture1_02.mzML	1	10	2	20
161117_SILAC_HeLa_UPS1_TMT10_SPS_MS3_Mixture1_03.mzML	1	1	3	21
161117_SILAC_HeLa_UPS1_TMT10_SPS_MS3_Mixture1_03.mzML	1	2	3	22
161117_SILAC_HeLa_UPS1_TMT10_SPS_MS3_Mixture1_03.mzML	1	3	3	23
161117_SILAC_HeLa_UPS1_TMT10_SPS_MS3_Mixture1_03.mzML	1	4	3	24
161117_SILAC_HeLa_UPS1_TMT10_SPS_MS3_Mixture1_03.mzML	1	5	3	25
161117_SILAC_HeLa_UPS1_TMT10_SPS_MS3_Mixture1_03.mzML	1	6	3	26
161117_SILAC_HeLa_UPS1_TMT10_SPS_MS3_Mixture1_03.mzML	1	7	3	27
161117_SILAC_HeLa_UPS1_TMT10_SPS_MS3_Mixture1_03.mzML	1	8	3	28
161117_SILAC_HeLa_UPS1_TMT10_SPS_MS3_Mixture1_03.mzML	1	9	3	29
161117_SILAC_HeLa_UPS1_TMT10_SPS_MS3_Mixture1_03.mzML	1	10	3	30

```
file <- substr(knime.flow.in[["URI-0"]], 6, nchar(knime.flow.in[["URI-0"]]))
MSstatsConverter_OpenMS_out <- read.csv(file)
data <- MSstatsConverter_OpenMS_out
```

and the second a path to the directory where the plots generated by MSstatsTMT should be saved. The R source node loads the required packages, such as dplyr for data wrangling, MSstatsTMT for analysis and MSstats for plotting. The inputs are further processed in the R View node.

Here, the data of the Input File is loaded into R using the flow variable ["URI-0"]: The OpenMStoMSstatsTMTFormat function preprocesses the OpenMS report and converts it into the required input format for MSstatsTMT, by filtering based on unique peptides and measurements in each MS run.

Afterwards different normalization steps are performed (global, protein, runs) as well as data imputation by using the msstats method. In addition peptide level data is summarized to protein level data.

There a lot of different possibilities to configure this method please have a look at the MSstatsTMT package for additional detailed information <http://bioconductor.org/packages/release/bioc/html/MSstatsTMT.html>

The next step is the comparisons of the different conditions, here either a pairwise comparison can be performed or a confusion matrix can be created. The goal is to detect and compare the UPS peptides spiked in at different concentrations.

The constructed confusion matrix is used in the groupComparisonTMT function to

```
processed.data <- OpenMStoMSstatsTMTFormat(data)
```

Figure 25: MSstatsTMT workflow segment

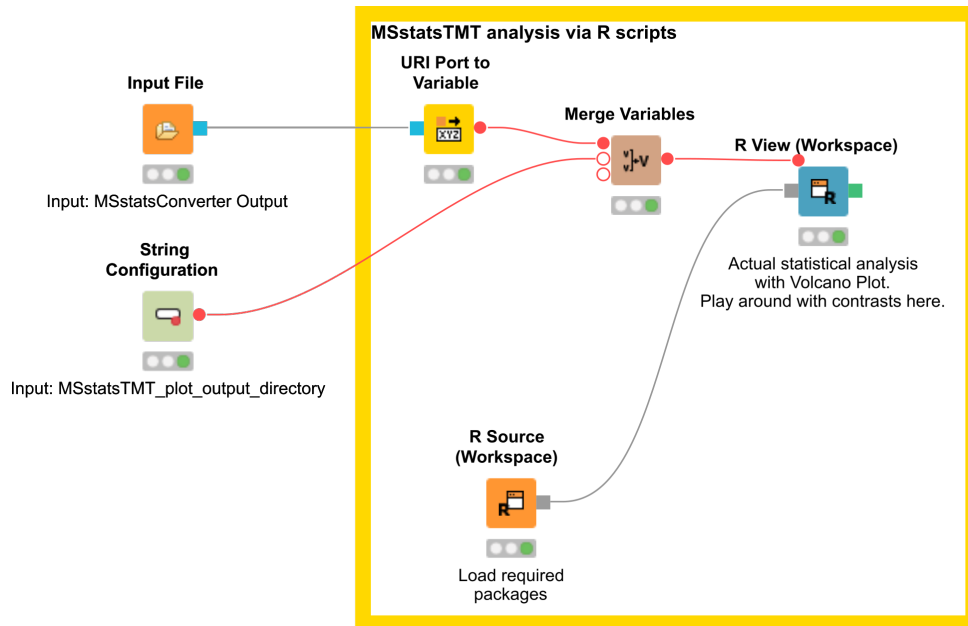

```
quant.data <- proteinSummarization(processed.data,
                                   method="msstats",
                                   global_norm=TRUE,
                                   reference_norm=TRUE,
                                   MBimpute = TRUE,
                                   maxQuantileforCensored = NULL,
                                   remove_norm_channel = TRUE,
                                   remove_empty_channel = TRUE)
```

```
# prepare contrast matrix
unique(quant.data$Condition)

comparison<-matrix(c(-1,0,0,1,
                    0,-1,0,1,
                    0,0,-1,1,
                    0,1,-1,0,
                    1,-1,0,0), nrow=5, byrow = T)

# Set the names of each row
row.names(comparison)<- contrasts <- c("1-0125",
                                     "1-05",
                                     "1-0667",
                                     "05-0667",
                                     "0125-05")

# Set the column names
colnames(comparison)<- c("0.125", "0.5", "0.667", "1")
```

Table 5: Experimental Design 2

Sample	MSstats_Condition	MSstats_BioReplicate	MSstats_Mixture	LabelName
1	Norm	Norm	1	126
2	0.667	0.667	1	127N
3	0.125	0.125	1	127C
4	0.5	0.5	1	128N
5	1	1	1	128C
6	0.125	0.125	1	129N
7	0.5	0.5	1	129C
8	1	1	1	130N
9	0.667	0.667	1	130C
10	Norm	Norm	1	131
11	Norm	Norm	1	126
12	0.667	0.667	1	127N
13	0.125	0.125	1	127C
14	0.5	0.5	1	128N
15	1	1	1	128C
16	0.125	0.125	1	129N
17	0.5	0.5	1	129C
18	1	1	1	130N
19	0.667	0.667	1	130C
20	Norm	Norm	1	131
21	Norm	Norm	1	126
22	0.667	0.667	1	127N
23	0.125	0.125	1	127C
24	0.5	0.5	1	128N
25	1	1	1	128C
26	0.125	0.125	1	129N
27	0.5	0.5	1	129C
28	1	1	1	130N
29	0.667	0.667	1	130C
30	Norm	Norm	1	131

```
data.res <- groupComparisonTMT(data = quant.data,
                              contrast.matrix = comparison,
                              moderated = TRUE, # do moderated t test
                              adj.method = "BH") # multiple comparison adjustment
data.res <- data.res %>% filter(!is.na(Protein))
```

test for significant changes in protein abundance across conditions based on a family of linear mixed-effects models in TMT experiments.

In the next step the comparison can be plotted using the `groupComparisonPlots` function by `MSstats`

Here, we have an example output of the R View, which depicts the significant regulated UPS proteins in the comparison of 125 to 05 (Fig. 26).

All plots are saved to the in the beginning specified output directory in addition.

5.4 Note

The isobaric analysis does not always have to be performed on protein level, for example for phosphoproteomics studies one is usually interested on the peptide level - in addition inference on peptides with post-translational modification is not straight forward. Here, we present an additional workflow on peptide level, which can potentially be adapted and used for such cases. Please see [Workflows](#) ▶ [Identification_quantification](#)

```
library(MSstats)
groupComparisonPlots(data=data.res.mod, type="VolcanoPlot", address=F, which.Comparison =
  ↪ "0125-05", sig = 0.05)
```

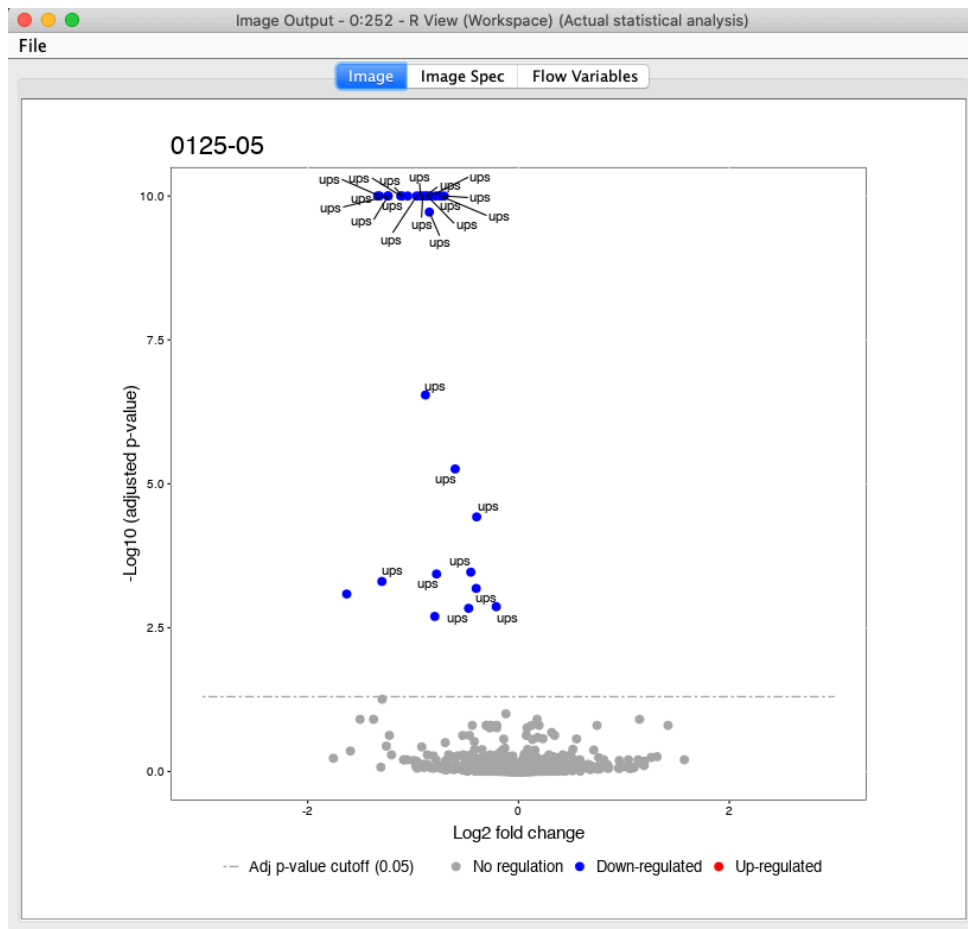

Figure 26: Volcanoplots of the group comparison regarding 0125 to 05.

6 Label-free quantification of metabolites

6.1 Introduction

Quantification and identification of chemical compounds are basic tasks in metabolomic studies. In this tutorial session we construct a UPLC-MS based, label-free quantification and identification workflow. Following quantification and identification we then perform statistical downstream analysis to detect quantification values that differ significantly between two conditions. This approach can, for example, be used to detect biomarkers. Here, we use two spike-in conditions of a dilution series (0.5 mg/l and 10.0 mg/l, male blood background, measured in triplicates) comprising seven isotopically labeled compounds. The goal of this tutorial is to detect and quantify these differential spike-in compounds against the complex background.

6.2 Basics of non-targeted metabolomics data analysis

For the metabolite quantification we choose an approach similar to the one used for peptides, but this time based on the OpenMS FeatureFinderMetabo method. This feature finder again collects peak picked data into individual mass traces. The reason why we need a different feature finder for metabolites lies in the step after trace detection: the aggregation of isotopic traces belonging to the same compound ion into the same feature. Compared to peptides with their averagine model, small molecules have very different isotopic distributions. To group small molecule mass traces correctly, an aggregation model tailored to small molecules is thus needed.

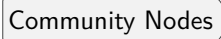
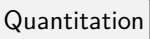
- Create a new workflow called for instance "Metabolomics".
- Add an Input File node and configure it with one mzML file from the  Example_Data ▶ Metabolomics ▶ datasets.
- Add a FeatureFinderMetabo node (from  OpenMS ) and connect the first output port of the Input File to the FeatureFinderMetabo.
- For an optimal result adjust the following settings. Please note that some of these are advanced parameters.
- Connect a Output Folder to the output of the FeatureFinderMetabo (see Fig. 27).

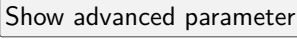
In the following advanced parameters will be **highlighted**. These parameter can be altered if the  field in the specific tool is activated (right bottom corner - see 2.4.2).

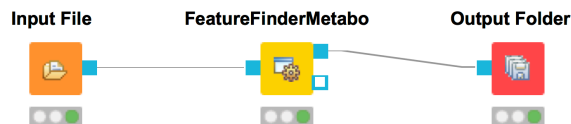

Figure 27: FeatureFinderMetabo workflow.

parameter	value
<i>algorithm</i> → <i>common</i> → <i>chrom_fwhm</i>	8.0
<i>algorithm</i> → <i>mtd</i> → <i>trace_termination_criterion</i>	sample_rate
<i>algorithm</i> → <i>mtd</i> → <i>min_trace_length</i>	3.0
<i>algorithm</i> → <i>mtd</i> → <i>max_trace_length</i>	600.0
<i>algorithm</i> → <i>epd</i> → <i>width_filtering</i>	off
<i>algorithm</i> → <i>ffm</i> → <i>report_convex_hulls</i>	true

The parameters change the behavior of FeatureFinderMetabo as follows:

- **chrom_fwhm:** The expected chromatographic peak width in seconds.
- **trace_termination_criterion:** In the first stage FeatureFinderMetabo assembles mass traces with a pre-defined mass accuracy. If this parameter is set to 'outlier', the extension of a mass trace is stopped after a predefined number of consecutive outliers is found. If this parameter is set to 'sample_rate', the extension of a mass trace is stopped once the ratio of collected peaks versus visited spectra falls below the ratio given by min_sample_rate.
- **min_trace_length:** Minimal length of a mass trace in seconds. Choose a small value, if you want to identify low-intensity compounds.
- **max_trace_length:** Maximal length of a mass trace in seconds. Set this parameter to -1 to disable the filtering by maximal length.
- **width_filtering:** FeatureFinderMetabo can remove features with unlikely peak widths from the results. If activated it will use the interval provided by the parameters min_fwhm and max_fwhm.
- **report_convex_hulls:** If set to true, convex hulls including mass traces will be reported for all identified features. This increases the output size considerably.

The output file .featureXML can be visualized with TOPPView on top of the used .mzML file - in a so called *layer* - to look at the identified features.

First start TOPPView and open the example .mzML file (see Fig. 28). Afterwards open the .featureXML output as new layer (see Fig. 29). The overlay is depicted in Figure 30.

The zoom of the .mzML - .featureXML overlay shows the individual mass traces and the assembly of those in a feature (see Fig. 31).

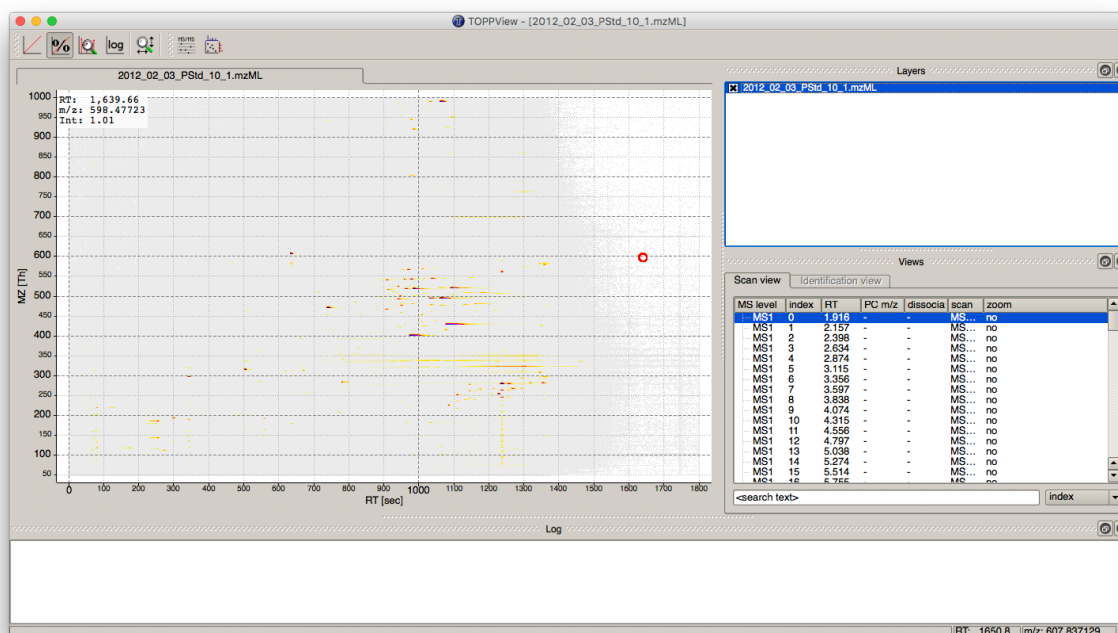

Figure 28: Opened .mzML in TOPPView.

The workflow can be extended for multi-file analysis, here an Input Files is to be used instead of the Input File. In front of the FeatureFinderMetabo a ZipLoopStart and behind ZipLoopEnd has to be used, since FeatureFinderMetabo will analysis on file to file bases.

To facilitate the collection of features corresponding to the same compound ion across different samples, an alignment of the samples' feature maps along retention time is often helpful. In addition to local, small-scale elution differences, one can often see constant retention time shifts across large sections between samples. We can use linear transformations to correct for these large scale retention differences. This brings the majority of corresponding compound ions close to each other. Finding the correct corresponding ions is then faster and easier, as we don't have to search as far around individual features.

- After the ZipLoopEnd node add a MapAlignerPoseClustering node (Community Nodes > OpenMS > Map Alignment), set its Output Type to featureXML, and adjust the following settings

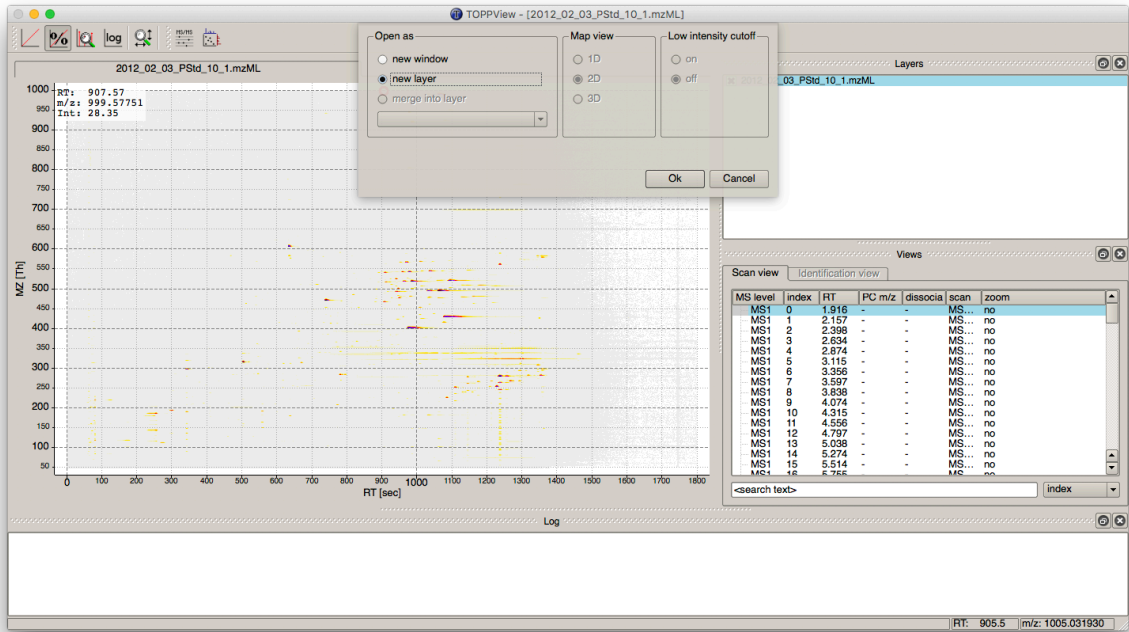

Figure 29: Add new layer in TOPPView.

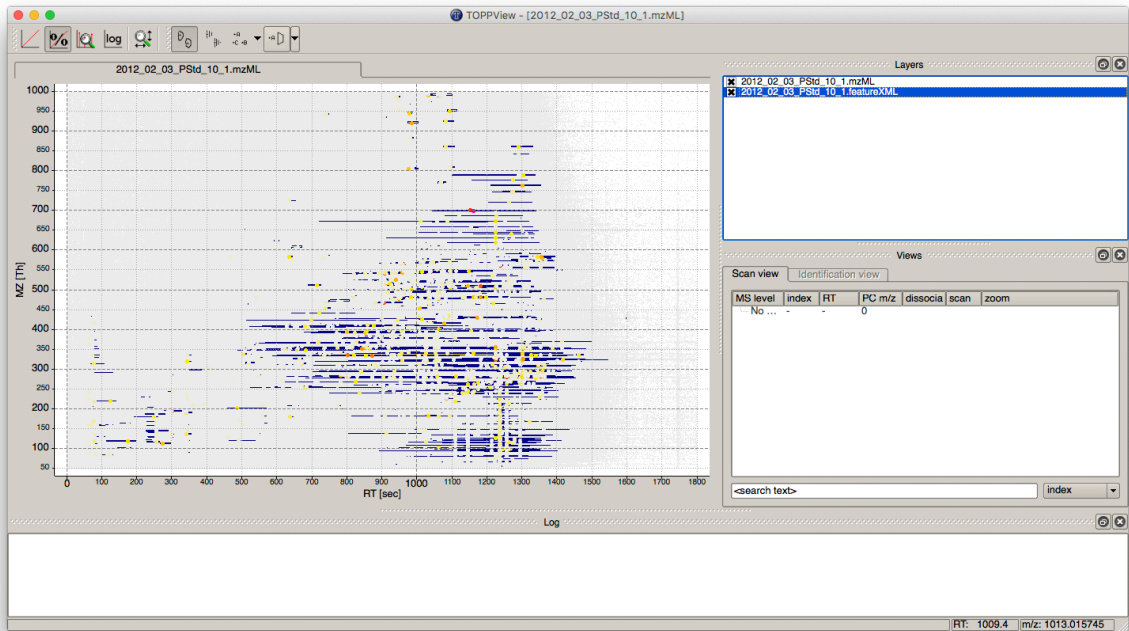

Figure 30: Overlay of the .mzML layer with the .featureXML layer.

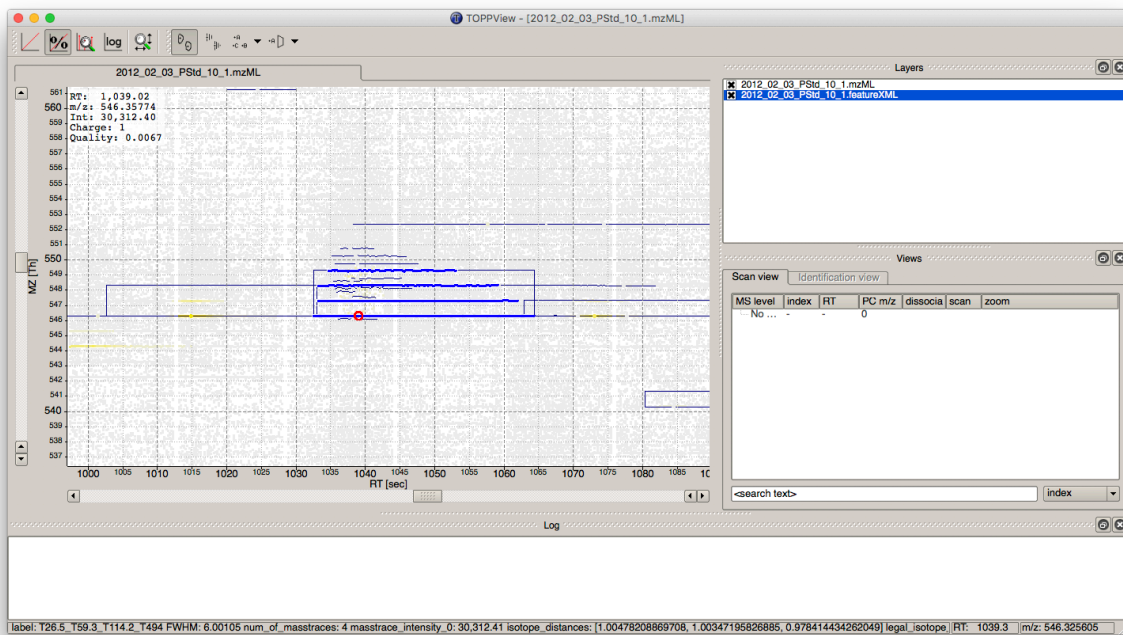

Figure 31: Zoom of the overlay of the .mzML with the .featureXML layer. Here the individual isotope traces (blue lines) are assembled into a feature here shown as convex hull (rectangular box).

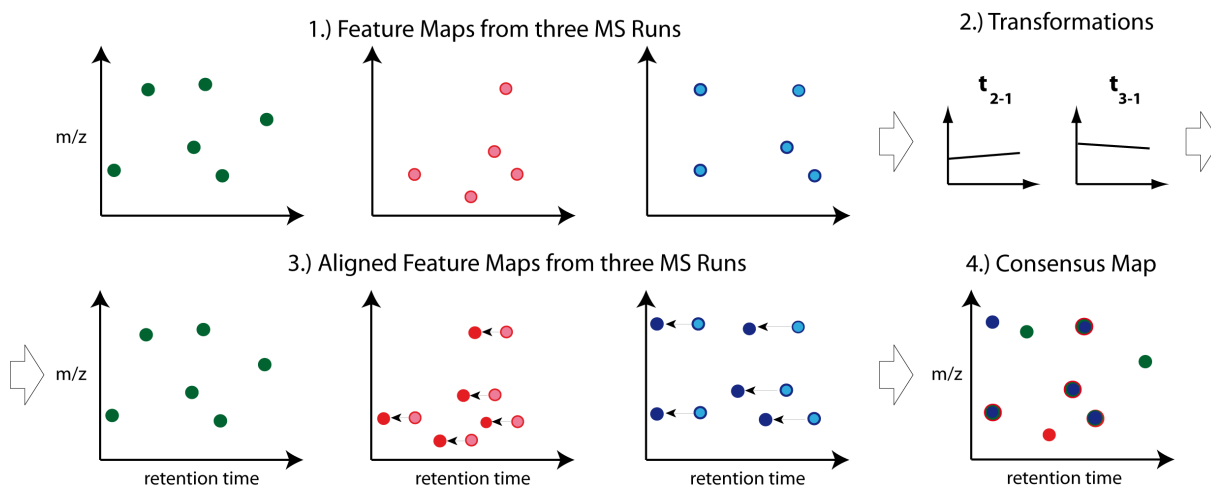

Figure 32: **Map alignment.** The first feature map is used as a reference to which other maps are aligned. The calculated transformation brings corresponding features into close retention time proximity. Linking of these features form a so-called consensus features of a *consensus map*.

parameter	value
<i>algorithm</i> → <i>max_num_peaks_considered</i>	-1
<i>algorithm</i> → <i>superimposer</i> → <i>mz_pair_max_distance</i>	0.005
<i>algorithm</i> → <i>superimposer</i> → <i>num_used_points</i>	10000
<i>algorithm</i> → <i>pairfinder</i> → <i>distance_RT</i> → <i>max_difference</i>	20.0
<i>algorithm</i> → <i>pairfinder</i> → <i>distance_MZ</i> → <i>max_difference</i>	20.0
<i>algorithm</i> → <i>pairfinder</i> → <i>distance_MZ</i> → <i>unit</i>	ppm

MapAlignerPoseClustering provides an algorithm to align the retention time scales of multiple input files, correcting shifts and distortions between them. Retention time adjustment may be necessary to correct for chromatography differences e.g. before data from multiple LC-MS runs can be combined (feature linking). The alignment algorithm implemented here is the pose clustering algorithm.

The parameters change the behavior of MapAlignerPoseClustering as follows:

- **max_num_peaks_considered:** The maximal number of peaks/features to be considered per map. To use all, set this parameter to -1.
- **mz_pair_max_distance:** Maximum of m/z deviation of corresponding elements in different maps. This condition applies to the pairs considered in hashing.
- **num_used_points:** Maximum number of elements considered in each map (selected by intensity). Use a smaller number to reduce the running time and to disregard weak signals during alignment.
- **distance_RT → max_difference:** Features that have a larger RT difference will never be paired.
- **distance_MZ → max_difference:** Features that have a larger m/z difference will never be paired.
- **distance_MZ → unit:** Unit used for the parameter distance_MZ max_difference, either Da or ppm.

The next step after retention time correction is the grouping of corresponding features in multiple samples. In contrast to the previous alignment, we assume no linear relations of features across samples. The used method is tolerant against local swaps in elution order.

- After the MapAlignerPoseClustering add a FeatureLinkerUnlabeledQT (Community Nodes >> OpenMS >> Map Alignment) and adjust the following settings

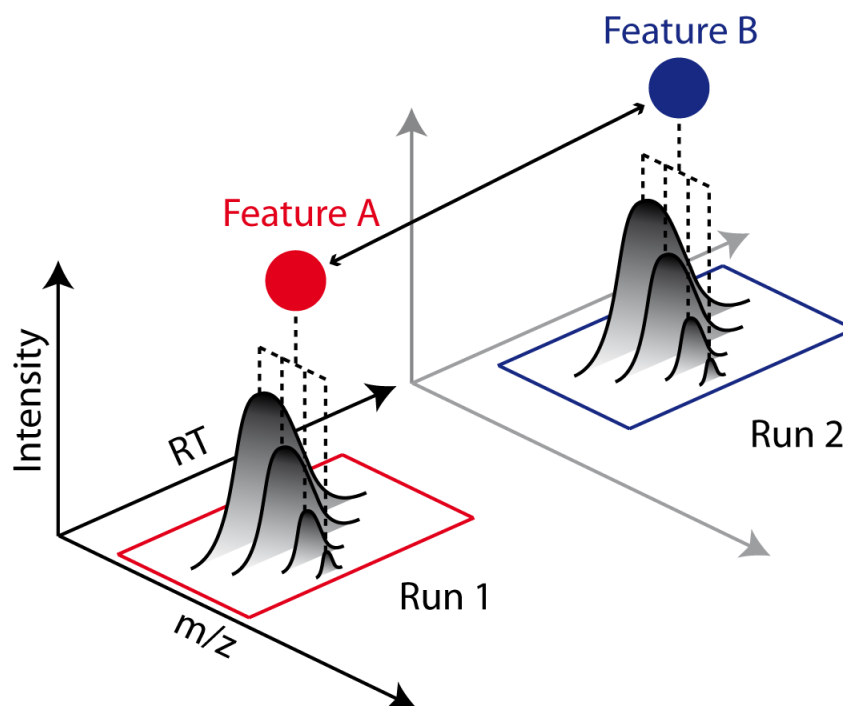

Figure 33: **Feature linking**. Features A and B correspond to the same analyte. The linking of features between runs (indicated by an arrow) allows comparing feature intensities.

parameter	value
<i>algorithm</i> → <i>distance_RT</i> → <i>max_difference</i>	40.0
<i>algorithm</i> → <i>distance_MZ</i> → <i>max_difference</i>	20.0
<i>algorithm</i> → <i>distance_MZ</i> → <i>unit</i>	ppm

The parameters change the behavior of `FeatureLinkerUnlabeledQT` as follows (similar to the parameters we adjusted for `MapAlignerPoseClustering`):

- **distance_RT** → **max_difference**: Features that have a larger RT difference will never be paired.
 - **distance_MZ** → **max_difference**: Features that have a larger m/z difference will never be paired.
 - **distance_MZ** → **unit**: Unit used for the parameter `distance_MZ max_difference`, either Da or ppm.
- After the `FeatureLinkerUnlabeledQT` add a `TextExporter` node (Community Nodes > OpenMS > File Handling).
 - Add an `Output Folder` node and configure it with an output directory where you want to store the resulting files.
 - Run the pipeline and inspect the output.

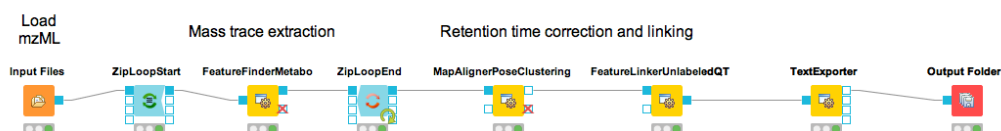

Figure 34: Label-free quantification workflow for metabolites

You should find a single, tab-separated file containing the information on where metabolites were found and with which intensities. You can also add Output Folder nodes at different stages of the workflow and inspect the intermediate results (e.g., identified metabolite features for each input map). The complete workflow can be seen in Figure 34. In the following section we will try to identify those metabolites. The FeatureLinkerUnlabeledQT output can be visualized in ToppView on top of the input and output of the FeatureFinderMetabo (see Fig 35).

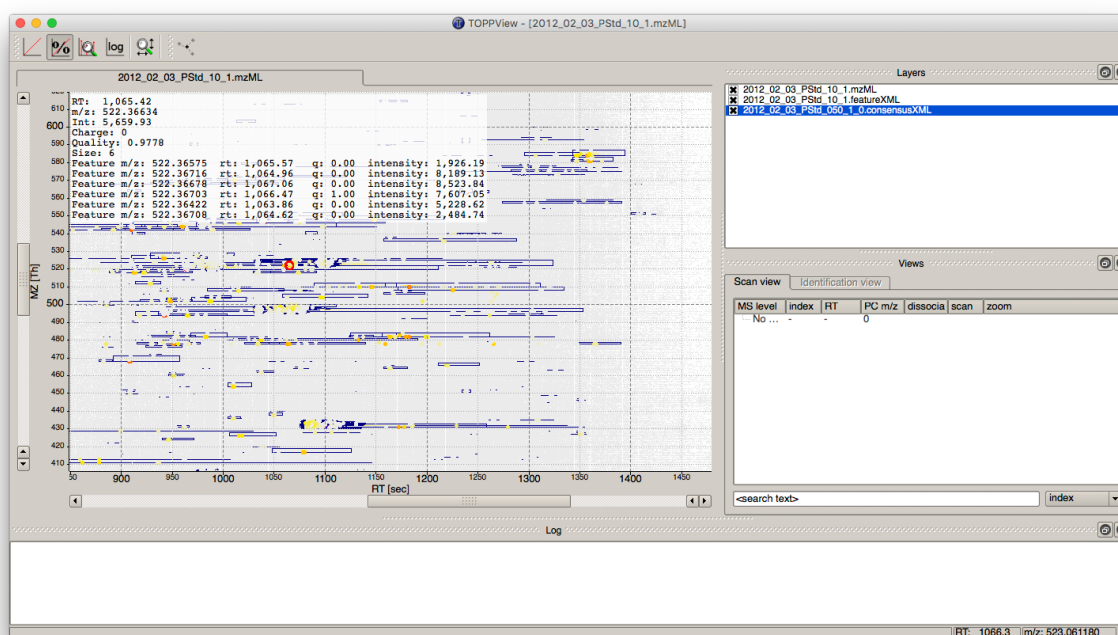





Figure 35: Visualization of .consensusXML output over the .mzML and .featureXML 'layer'.

6.3 Basic metabolite identification

At the current state we found several metabolites in the individual maps but so far don't know what they are. To identify metabolites OpenMS provides multiple tools, including search by mass: the AccurateMassSearch node searches observed masses

against the Human Metabolome Database (HMDB)[14, 15, 16]. We start with the workflow from the previous section (see Figure 34).

- Add a FileConverter node (Community Nodes >> OpenMS >> File Handling) and connect the output of the FeatureLinkerUnlabeledQT to the incoming port.
- Open the Configure dialog of the FileConverter and select the tab "Output-Types". In the drop down list for FileConverter.1.out select "featureXML".
- Add an AccurateMassSearch node (Community Nodes >> OpenMS >> Utilities) and connect the output of the FileConverter to the first port of the AccurateMassSearch.
- Add four Input File nodes and configure them with the following files
 -  Example_Data > Metabolomics > databases > PositiveAdducts.tsv
This file specifies the list of adducts that are considered in the positive mode. Each line contains the formula and charge of an adduct separated by a semicolon (e.g. M+H;1+). The mass of the adduct is calculated automatically.
 -  Example_Data > Metabolomics > databases > NegativeAdducts.tsv
This file specifies the list of adducts that are considered in the negative mode analogous to the positive mode.
 -  Example_Data > Metabolomics > databases > HMDBMappingFile.tsv
This file contains information from a metabolite database in this case from HMDB. It has three (or more) tab-separated columns: mass, formula, and identifier(s). This allows for an efficient search by mass.
 -  Example_Data > Metabolomics > databases > HMDB2StructMapping.tsv
This file contains additional information about the identifiers in the mapping file. It has four tab-separated columns that contain the identifier, name, SMILES, and INCHI. These will be included in the result file. The identifiers in this file must match the identifiers in the HMDBMappingFile.tsv.
- In the same order as they are given above connect them to the remaining input ports of the AccurateMassSearch node.
- Add an Output Folder node and connect the first output port of the AccurateMassSearch node to the Output Folder.

The result of the AccurateMassSearch node is in the mzTab format [17] so you can easily open it in a text editor or import it into Excel or KNIME, which we will do in the next section. The complete workflow from this section is shown in Figure 36.

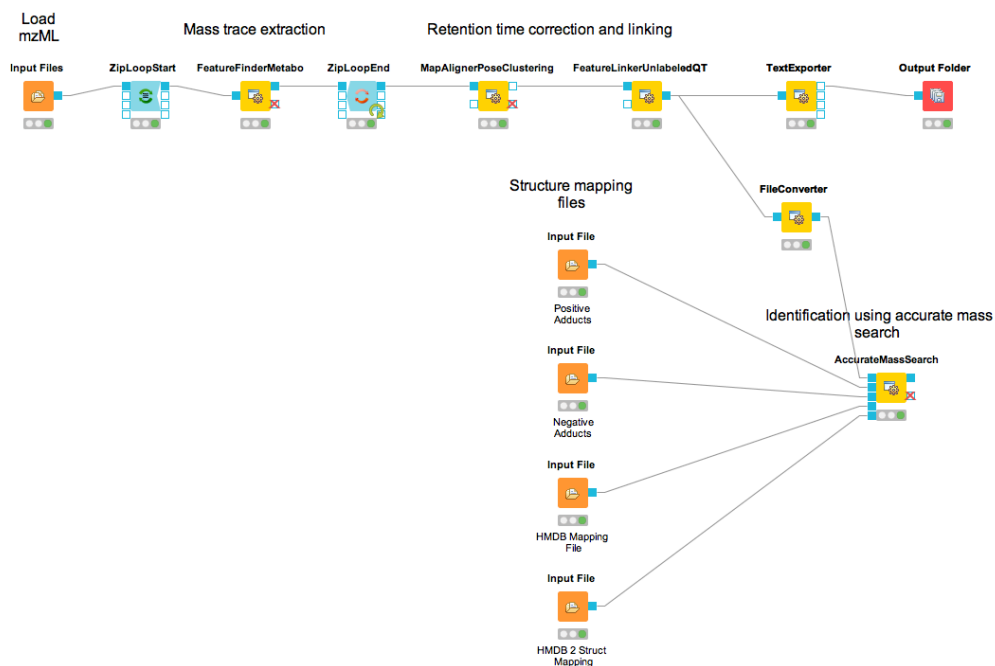

Figure 36: Label-free quantification and identification workflow for metabolites

6.3.1 Convert your data into a KNIME table

The result from the TextExporter node as well as the result from the AccurateMassSearch node are files while standard KNIME nodes display and process only KNIME tables. To convert these files into KNIME tables we need two different nodes. For the AccurateMassSearch results we use the MzTabReader node (Community Nodes >> OpenMS >> Conversion >> mzTab) and its **Small Molecule Section** port. For the result of the TextExporter we use the ConsensusTextReader (Community Nodes >> OpenMS >> Conversion).

When executed, both nodes will import the OpenMS files and provide access to the data as KNIME tables. The retention time values are exported as a list using the MzTabReader based on the current PSI-Standard. This has to be parsed using the SplitCollectionColumn, which outputs a "Split Value 1" based on the first entry in the retention time list, which has to be renamed to retention time using the ColumnRename. You can now combine both tables using the Joiner node (Manipulation >> Column >> Split & Combine) and configure it to match the m/z and retention time values of the respective tables. The full workflow is shown in Figure 37.

6.3.2 Adduct grouping

Metabolites commonly co-elute as ions with different adducts (e.g., glutathione+H, glutathione+Na) or with charge-neutral modifications (e.g., water loss). Grouping such related ions allows to leverage information across features. For example, a low-intensity, single trace feature could still be assigned a charge and adduct due to a

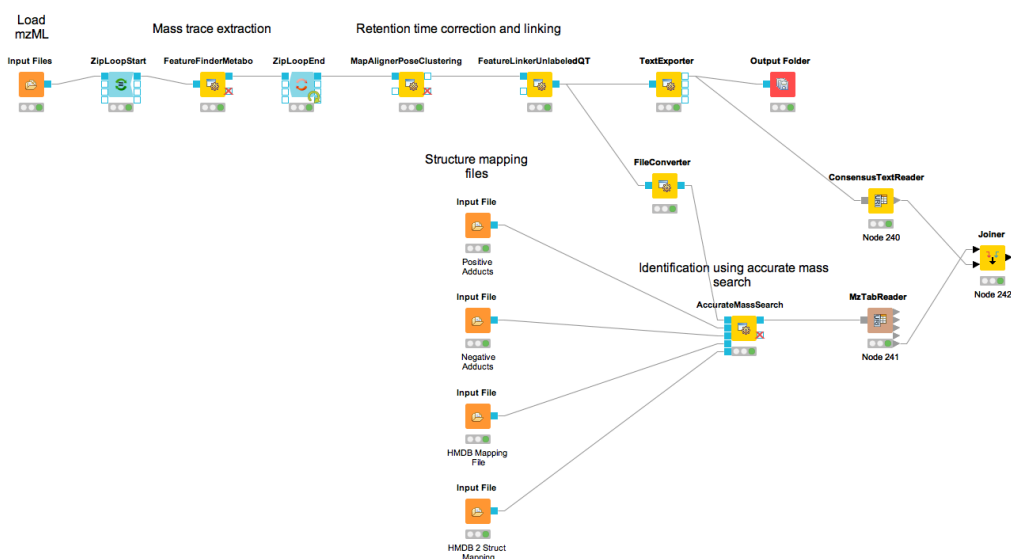

Figure 37: Label-free quantification and identification workflow for metabolites that loads the results into KNIME and joins the tables.

matching high-quality feature. Such information can then be used by several OpenMS tools, such as *AccurateMassSearch*, for example to narrow down candidates for identification.

For this grouping task, we provide the *MetaboliteAdductDecharger* node. Its method explores the combinatorial space of all adduct combinations in a charge range for optimal explanations. Using defined adduct probabilities, it assigns co-eluting features having suitable mass shifts and charges those adduct combinations which maximize overall ion probabilities.

The tool works natively with featureXML data, allowing the use of reported convex hulls. On such a single-sample level, co-elution settings can be chosen more stringently, as ionization-based adducts should not influence the elution time: Instead, elution differences of related ions should be due to slightly differently estimated times for their feature centroids.

Alternatively, consensusXML data from feature linking can be converted for use, though with less chromatographic information. Here, the elution time averaging for features linked across samples, motivates wider co-elution tolerances.

The two main tool outputs are a consensusXML file with compound groups of related input ions, and a featureXML containing the input file but annotated with inferred adduct information and charges.

Options to respect or replace ion charges or adducts allow for example:

- Heuristic but faster, iterative adduct grouping (**MetaboliteAdductDecharger** → **MetaboliteFeatureDeconvolution** → `q_try` set to "feature") by chaining multiple *MetaboliteAdductDecharger* with growing adduct sets, charge ranges or

otherwise relaxed tolerances.

- More specific feature linking (**FeatureLinkerUnlabeledQT** → **algorithm** → **ignore_adduct** set to “false”)

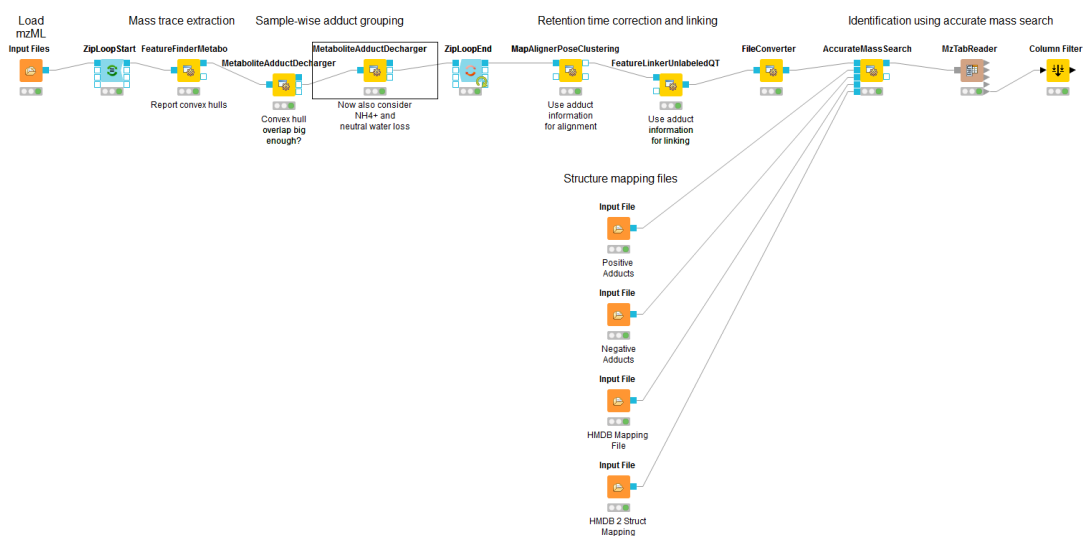

Figure 38: Metabolite Adduct Decharger adduct grouping workflow

Task



A modified metabolomics workflow with exemplary `MetaboliteAdductDecharger` use and parameters is provided in

`Workflows` ▶ `Metabolite_Adduct_Grouping.knwf`. Run the workflow, inspect tool outputs and compare `AccurateMassSearch` results with and without adduct grouping.

6.3.3 Visualizing data

Now that you have your data in KNIME you should try to get a feeling for the capabilities of KNIME.

Task



Check out the `Molecule Type Cast` node (`Chemistry` ▶ `Translators`) together with subsequent cheminformatics nodes (e.g. `RDKit From Molecule` (`Community Nodes` ▶ `RDKit` ▶ `Converters`)) to render the structural formula contained in the result table.

Task

- Have a look at the `Column Filter` node to reduce the table to the interesting columns, e.g., only the IDs, chemical formula, and intensities.

Task

- Try to compute and visualize the m/z and retention time error of the different feature elements (from the input maps) of each consensus feature. Hint: A nicely configured `Math Formula (Multi Column)` node should suffice.

6.3.4 Spectral library search

Identifying metabolites using only the accurate mass may lead to ambiguous results. In practice, additional information (e.g. the retention time) is used to further narrow down potential candidates. Apart from MS1-based features, tandem mass spectra (MS2) of metabolites provide additional information. In this part of the tutorial, we take a look on how metabolite spectra can be identified using a library of previously identified spectra.

Because these libraries tend to be large we don't distribute them with OpenMS.

Task

- Construct the workflow as shown in Fig. 39. Use the file `Example_Data` `Metabolomics` `datasets` `Metabolite_ID_SpectraDB_positive.mzML` as input for your workflow. You can use the spectral library from `Example_Data` `Metabolomics` `databases` `MetaboliteSpectralDB.mzML` as second input. The first input file contains tandem spectra that are identified by the `MetaboliteSpectralMatcher`. The resulting `mzTab` file is read back into a KNIME table. The retention time values are exported as a list based on the current PSI-Standard. This has to be parsed using the `SplitCollectionColumn`, which outputs a "Split Value 1" based on the first entry in the retention time list, which has to be renamed to retention time using the `ColumnRename` before it is stored in an Excel table. Make sure that you connect the `MzTabReader` port corresponding to the Small Molecule Section to the `Excel writer (XLS)`. Please select the "add column headers" option in the `Excel writer (XLS)`.

Run the workflow and inspect the output.

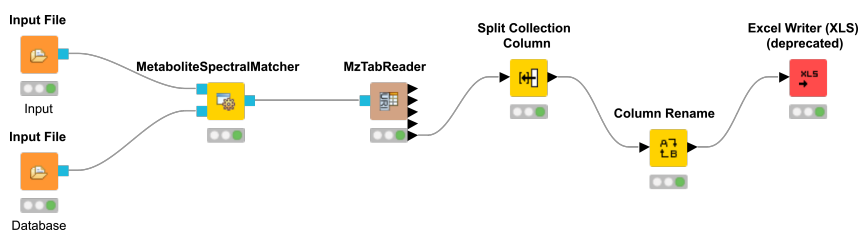

Figure 39: Spectral library identification workflow

6.3.5 Manual validation

In metabolomics, matches between tandem spectra and spectral libraries are manually validated. Several commercial and free online resources exist which help in that task. Some examples are:

- mzCloud contains only spectra from Thermo Orbitrap instruments. The webpage requires Microsoft Silverlight which currently does not work in modern browsers (see <https://www.mzcloud.org/DataViewer>).
- MassBank North America (MoNA) has spectra from different instruments but falls short in number of spectra (compared to Metlin and mzCloud) <http://mona.fiehnlab.ucdavis.edu/spectra/display/KNA00122>
- METLIN includes 961,829 molecules ranging from lipids, steroids, metabolites, small peptides, carbohydrates, exogenous drugs and toxicants. In total over 14,000 metabolites.

Here, we will use METLIN to manually validate metabolites.

Task



Check in the .xlsx output from the Excel writer (XLS) if you can find glutathione. Use the retention time column to find the spectrum in the mzML file. Here open the file in the `Example_Data` ▶ `Metabolomics` ▶ `datasets` ▶ `Metabolite_ID_SpectraDB_positive.mzML` in TOPPView. The MSMS spectrum with the retention time of 67.6 s is used as example. The spectrum can be selected based on the retention time in the scan view window. Therefore the MS1 spectrum with the retention time of 66.9 s has to be double clicked and the MSMS spectra recorded in this time frame will show up. Select the tandem spectrum of Glutathione, but do not close TOPPView, yet.

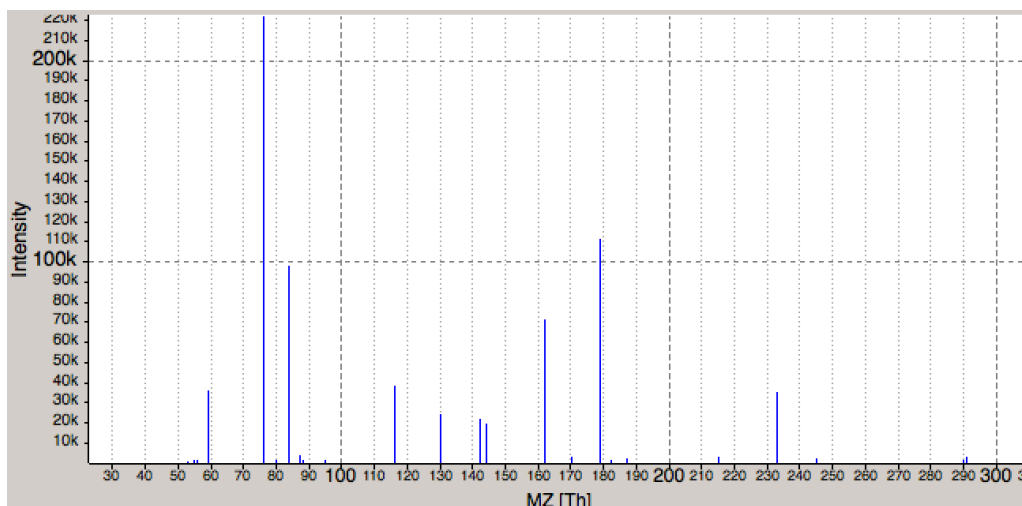

Figure 40: Tandem spectrum of glutathione. Visualized in TOPPView.

Task



On the METLIN homepage search for Glutathione using the (https://metlin.scripps.edu/landing_page.php?pgcontent=advanced_search). Note that free registration is required. Which collision energy (and polarity) gives the best (visual) match to your experimental spectrum in TOPPView? Here you can compare the fragmentation patterns in both spectra shown by the Intensity or relative Intensity, the m/z of a peak and the distance between peaks. Each distance between two peaks corresponds to a fragment of elemental composition (e.g., NH₂ with the charge of one would have mass of two peaks of 16.023 Th).

6.3.6 *De novo* identification

Another method for MS₂ spectra-based metabolite identification is *de novo* identification. This approach can be used in addition to the other methods (accurate mass search, spectral library search) or individually if no spectral library is available. In this part of the tutorial, we discuss how metabolite spectra can be identified using *de novo* tools. To this end, the tools SIRIUS and CSI:FingerID ([18, 19, 20]) were integrated in the OpenMS Framework as SiriusAdapter. SIRIUS uses isotope pattern analysis to detect the molecular formula and further analyses the fragmentation pattern of a compound using fragmentation trees. CSI:FingerID is a method for searching a fingerprint of a small molecule (metabolite) in a molecular structure database.

The node is able to work in different modes depending on the provided input.

- Input: mzML - SiriusAdapter will search all MS₂ spectra in a map.

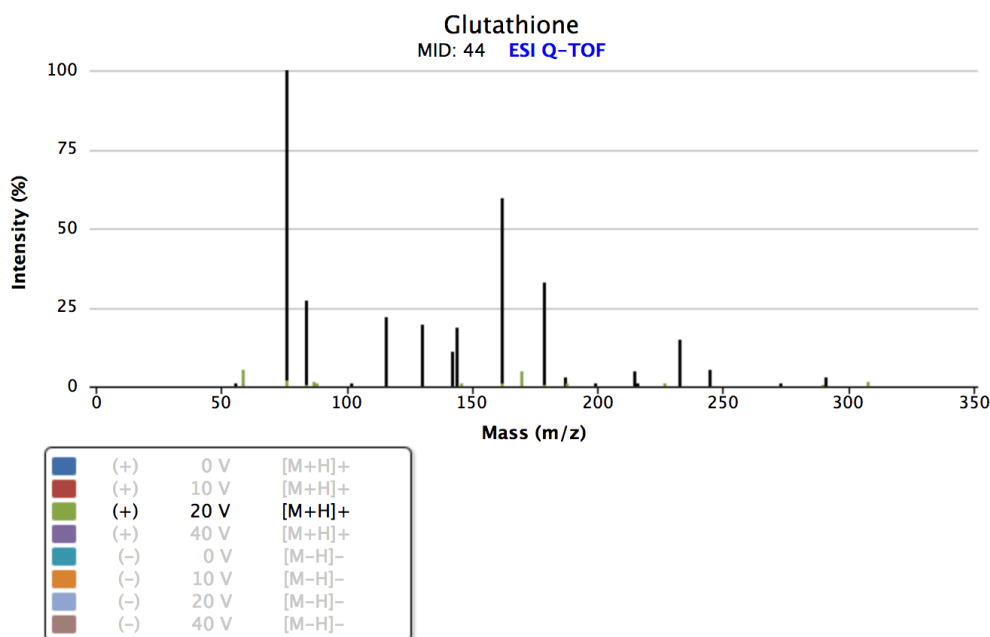

Figure 41: Tandem spectrum of glutathione. Visualized in Metlin. Note that several fragment spectra from varying collision energies are available.

- Input: mzML, featureXML (FeatureFinderMetabo) - SiriusAdapter can use the provided feature information to reduce the search space to valid features with MS2 spectra. Additionally it can use the isotopic trace information.
- Input: mzML, featureXML (FeatureFinderMetabo / MetaboliteAdductDecharger / AccurateMassSearch) - SiriusAdapter can use the feature information as mentioned above together with feature adduct information from adduct grouping or previous identification.

The last approach is the preferred one, as SIRIUS gains a lot of additional information by using the OpenMS tools for preprocessing.

Task



Construct the workflow as shown in Fig. 42.

Use the file `Example_Data\Metabolomics\datasets`

`\Metabolite_DeNovoID.mzML` as input for your workflow.

Run the workflow and inspect the output.

The output consists of two mzTab files and an internal .ms file. One mzTab for SIRIUS and the other for the CSI:FingerID. These provide information about the chemical formula, adduct and the possible compound structure. The information is referenced to the spectrum used in the analysis. Additional information can be extracted from the

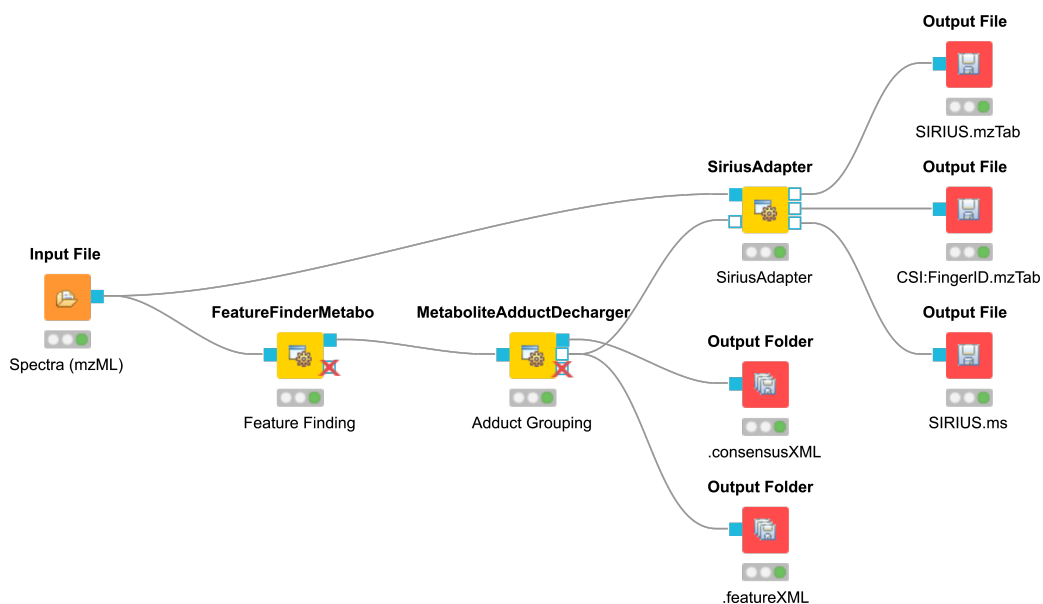

Figure 42: *De novo* identification workflow

SiriusAdapter by setting an "out_workspace_directory". Here the SIRIUS workspace will be provided after the calculation has finished. This workspace contains information about annotated fragments for each successfully explained compound.

6.4 Downstream data analysis and reporting

In this part of the metabolomics session we take a look at more advanced downstream analysis and the use of the statistical programming language R. As laid out in the introduction we try to detect a set of spike-in compounds against a complex blood background. As there are many ways to perform this type of analysis we provide a complete workflow.

Task

Import the workflow from Workflows ▶ metabolite_ID.knwf in KNIME:
 Import KNIME Workflow...

The section below will guide you in your understanding of the different parts of the workflow. Once you understood the workflow you should play around and be creative. Maybe create a novel visualization in KNIME or R? Do some more elaborate statistical analysis? Note that some basic R knowledge is required to fully understand the processing in R Snippet nodes.

6.4.1 Signal processing and data preparation for identification

This part is analogous to what you did for the simple metabolomics pipeline.

6.4.2 Data preparation for quantification

The first part is identical to what you did for the simple metabolomics pipeline. Additionally, we convert zero intensities into NA values and remove all rows that contain at least one NA value from the analysis. We do this using a very simple R Snippet and subsequent Missing Value filter node.

Task



Inspect the R Snippet by double-clicking on it. The KNIME table that is passed to an R Snippet node is available in R as a data.frame named `knime.in`. The result of this node will be read from the data.frame `knime.out` after the script finishes. Try to understand and evaluate parts of the script (Eval Selection). In this dialog you can also print intermediary results using for example the R command `head(knime.in)` or `cat(knime.in)` to the Console pane.

6.4.3 Statistical analysis

After we linked features across all maps, we want to identify features that are significantly deregulated between the two conditions. We will first scale and normalize the data, then perform a t-test, and finally correct the obtained p-values for multiple testing using Benjamini-Hochberg. All of these steps will be carried out in individual R Snippet nodes.

- Double-click on the first R Snippet node labeled "log scaling" to open the R Snippet dialog. In the middle you will see a short R script that performs the log scaling. To perform the log scaling we use a so-called regular expression (`grep`) to select all columns containing the intensities in the six maps and take the \log_2 logarithm.
- The output of the log scaling node is also used to draw a boxplot that can be used to examine the structure of the data. Since we only want to plot the intensities in the different maps (and not m/z or rt) we first use a Column Filter node to keep only the columns that contain the intensities. We connect the resulting table to a Box Plot node which draws one box for every column in the input table. Right-click and select `View: Box Plot`.
- The median normalization is performed in a similar way to the log scaling. First we calculate the median intensity for each intensity column, then we subtract the median from every intensity.

- Open the `Box Plot` connected to the normalization node and compare it to the box plot connected to the log scaling node to examine the effect of the median normalization.
- To perform the t-test we defined the two groups we want to compare. Finally we save the p-values and fold-changes in two new columns named p-value and FC.
- The `Numeric Row Splitter` is used to filter less interesting parts of the data. In this case we only keep columns where the fold-change is ≥ 2 .
- We adjust the p-values for multiple testing using Benjamini-Hochberg and keep all consensus features with a q-value ≤ 0.01 (i.e. we target a false-discovery rate of 1%).

6.4.4 Interactive visualization

KNIME supports multiple nodes for interactive visualization with interrelated output. The nodes used in this part of the workflow exemplify this concept. They further demonstrate how figures with data dependent customization can be easily realized using basic KNIME nodes. Several simple operations are concatenated in order to enable an interactive volcano plot.

- We first log-transform fold changes and p-values in the `R Snippet` node. We then append columns noting interesting features (concerning fold change and p-value).
- With this information, we can use various `Manager` nodes (`Views` `Property`) to emphasize interesting data points. The configuration dialogs allow us to select columns to change color, shape or size of data points dependent on the column values.
- The `Scatter Plot` node (`Views`) enables interactive visualization of the logarithmized values as a volcano plot: the log-transformed values can be chosen in the 'Column Selection' tab of the plot view. Data points can be selected in the plot and highlighted via the menu option. The highlighting transfers to all other interactive nodes connected to the same data table. In our case, selection and the highlighting will also occur in the `Interactive Table` node (`Views`).
- Output of the interactive table can then be filtered via the "HiLite" menu tab. For example, we could restrict shown rows to points highlighted in the volcano plot.

```
#Include the next line if you also have to install ggplot2:  
install.packages("ggplot2")  
#Include the following lines to install ggfortify:  
install.packages("ggfortify")  
library(ggplot2)  
library(ggfortify)
```

Task



Inspect the nodes of this section. Customize your visualization and possibly try to visualize other aspects of your data.

6.4.5 Advanced visualization

R Dependencies: This section requires that the R packages `ggplot2` and `ggfortify` are both installed. `ggplot2` is part of the *KNIME R Statistics Integration (Windows Binaries)* which should already be installed via the full KNIME installer, `ggfortify` however is not. In case that you use an R installation where one or both of them are not yet installed, add an `R Snippet` node and double-click to configure. In the *R Script* text editor, enter the following code: You can remove the `install.packages` commands once it was successfully installed.

Even though the basic capabilities for (interactive) plots in KNIME are valuable for initial data exploration, professional looking depiction of analysis results often relies on dedicated plotting libraries. The statistics language R supports the addition of a large variety of packages, including packages providing extensive plotting capabilities. This part of the workflow shows how to use R nodes in KNIME to visualize more advanced figures. Specifically, we make use of different plotting packages to realize heatmaps.

- The used `RView (Table)` nodes combine the possibility to write R snippet code with visualization capabilities inside KNIME. Resulting images can be looked at in the output `RView`, or saved via the `Image Writer (Port)` node.
- The heatmap nodes make use of the `gplots` library, which is by default part of the `R Windows binaries` (for full KNIME version 3.1.1 or higher). We again use regular expressions to extract all measured intensity columns for plotting. For clarity, feature names are only shown in the heatmap after filtering by fold changes.

6.4.6 Data preparation for Reporting

Following the identification, quantification and statistical analysis our data is merged and formatted for reporting. First we want to discard our normalized and logarithmized intensity values in favor of the original ones. To this end we first remove the intensity columns (Column Filter) and add the original intensities back (Joiner). For that we use an *Inner Join*² with the Joiner node. In the dialog of the node we add two entries for the Joining Columns and for the first column we pick "retention_time" from the top input (i.e. the AccurateMassSearch output) and "rt_cf" (the retention time of the consensus features) for the bottom input (the result from the quantification). For the second column you should choose "exp_mass_to_charge" and "mz_cf" respectively to make the joining unique. Note that the workflow needs to be executed up to the previous nodes for the possible selections of columns to appear.

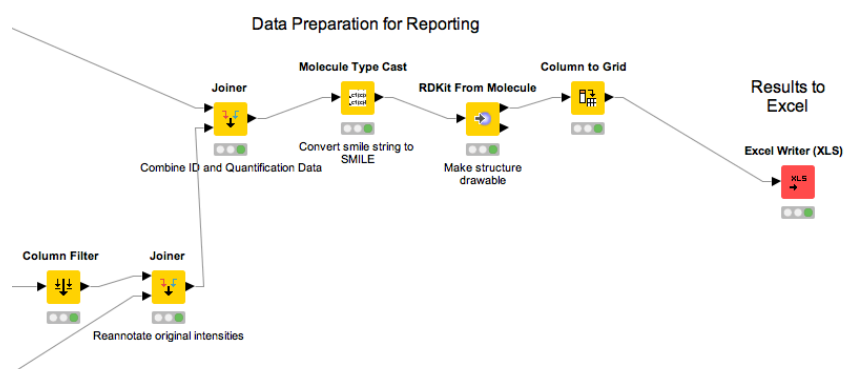

Figure 43: Data preparation for reporting

Question



What happens if we use a *Left Outer Join*, *Right Outer Join* or *Full Outer Join* instead of the *Inner Join*?

Task



Inspect the output of the join operation after the Molecule Type Cast and RDKit molecular structure generation.

While all relevant information is now contained in our table the presentation could be improved. Currently, we have several rows corresponding to a single consensus feature (=linked feature) but with different, alternative identifications. It would be more convenient to have only one row for each consensus feature with all accurate

²*Inner Join* is a technical term that describes how database tables are merged.

mass identifications added as additional columns. To this end, we use the Column to Grid node that flattens several rows with the same consensus number into a single one. Note that we have to specify the maximum number of columns in the grid so we set this to a large value (e.g. 100). We finally export the data to an Excel file (XLS Writer).

7 OpenSWATH

7.1 Introduction

OpenSWATH [21] allows the analysis of LC-MS/MS DIA (data independent acquisition) data using the approach described by Gillet *et al.* [22]. The DIA approach described there uses 32 cycles to iterate through precursor ion windows from 400-426 Da to 1175-1201 Da and at each step acquires a complete, multiplexed fragment ion spectrum of all precursors present in that window. After 32 fragmentations (or 3.2 seconds), the cycle is restarted and the first window (400-426 Da) is fragmented again, thus delivering complete “snapshots” of all fragments of a specific window every 3.2 seconds.

The analysis approach described by Gillet et al. extracts ion traces of specific fragment ions from all MS2 spectra that have the same precursor isolation window, thus generating data that is very similar to SRM traces.

7.2 Installation of OpenSWATH

OpenSWATH has been fully integrated since OpenMS 1.10 [4, 2, 23, 24, 25]).

7.3 Installation of mProphet

mProphet (<http://www.mprophet.org/>) [26] is available as standalone script in `External_Tools` ▶ `mProphet` ▶ `.`. R (<http://www.r-project.org/>) and the package MASS (<http://cran.r-project.org/web/packages/MASS/>) are further required to execute mProphet. Please obtain a version for either Windows, Mac or Linux directly from CRAN.

PyProphet, a much faster reimplementation of the mProphet algorithm is available from PyPI (<https://pypi.python.org/pypi/pyprophet/>). The usage of pyprophet instead of mProphet is suggested for large-scale applications.

mProphet will be used in this tutorial.

7.4 Generating the Assay Library

7.4.1 Generating TraML from transition lists

OpenSWATH requires an assay library to be supplied in the TraML format [27]. To enable manual editing of transition lists, the TOPP tool TargetedFileConverter is available, which uses tab separated files as input. Example datasets are provided in  Example_Data ▶ OpenSWATH ▶ assay ▶ . Please note that the transition lists need to be named .tsv.

The header of the transition list contains the following variables (with example values in brackets):

Required Columns:

PrecursorMz

The mass-to-charge (m/z) of the precursor ion. (924.539)

ProductMz

The mass-to-charge (m/z) of the product or fragment ion. (728.99)

LibraryIntensity

The relative intensity of the transition. (0.74)

NormalizedRetentionTime

The **normalized** retention time (or iRT) [28] of the peptide. (26.5)

Targeted Proteomics Columns:

ProteinId

A unique identifier for the protein. (AQUA4SWATH_HMLangeA)

PeptideSequence

The unmodified peptide sequence. (ADSTGTLVITDPTR)

ModifiedPeptideSequence

The peptide sequence with UniMod modifications. (ADSTGTLVITDPTR(UniMod:267))

PrecursorCharge

The precursor ion charge. (2)

ProductCharge

The product ion charge. (2)

Grouping Columns:

```
TargetedFileConverter -in OpenSWATH_SGS_AssayLibrary_woDecoy.tsv -out  
↔ OpenSWATH_SGS_AssayLibrary_woDecoy.TraML
```

TransitionGroupId

A **unique** identifier for the transition group.

(AQUA4SWATH_HMLangeA_ADSTGTLVITDPTR(UniMod:267)/2)

TransitionId

A **unique** identifier for the transition.

(AQUA4SWATH_HMLangeA_ADSTGTLVITDPTR(UniMod:267)/2_y8)

Decoy

A binary value whether the transition is target or decoy. (target: 0, decoy: 1)

PeptideGroupLabel

Which label group the peptide belongs to.

DetectingTransition

Use transition for peak group detection. (1)

IdentifyingTransition

Use transition for peptidoform inference using IPF. (0)

QuantifyingTransition

Use transition to quantify peak group. (1)

For further instructions about generic transition list and assay library generation please see <http://openswath.org/en/latest/docs/generic.html>.

To convert transitions lists to TraML, use the TargetedFileConverter: Please use the absolute path to your OpenMS installation.

Linux or Mac

On the Terminal:

Windows

On the TOPP command line:

```
TargetedFileConverter.exe -in OpenSWATH_SGS_AssayLibrary_woDecoy.tsv -out  
↪ OpenSWATH_SGS_AssayLibrary_woDecoy.TraML
```

```
OpenSwathDecoyGenerator -in OpenSWATH_SGS_AssayLibrary_woDecoy.TraML -out  
↪ OpenSWATH_SGS_AssayLibrary.TraML -method shuffle -switchKR false
```

7.4.2 Appending decoys to a TraML file

In addition to the target assays, OpenSWATH requires decoy assays in the library which are later used for classification and error rate estimation. For the decoy generation it is crucial that the decoys represent the targets in a realistic but unnatural manner without interfering with the targets. The methods for decoy generation implemented in OpenSWATH include 'shuffle', 'pseudo-reverse', 'reverse' and 'shift'. To append decoys to a TraML, the TOPP tool `OpenSwathDecoyGenerator` can be used: Please use the absolute path to your OpenMS installation.

Linux or Mac

On the Terminal:

Windows

On the TOPP command line:

7.5 OpenSWATH KNIME

An example KNIME workflow for OpenSWATH is supplied in `Workflows` (Fig. 44). The example dataset can be used for this workflow (filenames in brackets):

1. Open `Workflows` ▶ `OpenSWATH.knwf` in KNIME: `File` ▶ `Import KNIME Workflow...`.
2. Select the normalized retention time (iRT) assay library in TraML format by double-clicking on node `Input File` ▶ `iRT Assay Library`.
(`Example_Data` ▶ `OpenSWATH` ▶ `assay` ▶ `OpenSWATH_iRT_AssayLibrary.TraML`)
3. Select the SWATH MS data in mzML format as input by double-clicking on node `Input File` ▶ `SWATH-MS files`.
(`Example_Data` ▶ `OpenSWATH` ▶ `data` ▶ `split_napedro_L120420_010_SW-*.nf.pp.mzML`)
4. Select the target peptide assay library in TraML format as input by double-clicking on node `Input Files` ▶ `Assay Library`.
(`Example_Data` ▶ `OpenSWATH` ▶ `assay` ▶ `OpenSWATH_SGS_AssayLibrary.TraML`)

```
OpenSwathDecoyGenerator.exe -in OpenSWATH_SGS_AssayLibrary_woDecoy.TraML -out  
↪ OpenSWATH_SGS_AssayLibrary.TraML -method shuffle -switchKR false
```

```
R --slave --args bin_dir=../../External_Tools/mProphet/ mquest=OpenSWATH_quant.tsv  
→ workflow=LABEL_FREE num_xval=5 run_log=FALSE write_classifier=1 write_all_pg=1 <  
→ ../../External_Tools/mProphet/mProphet.R
```

```
"C:\Program Files\R\R-3.5.1\bin\x86\R.exe" --slave --args  
→ bin_dir=../../External_Tools/mProphet/ mquest=OpenSWATH_quant.tsv  
→ workflow=LABEL_FREE num_xval=5 run_log=FALSE write_classifier=1 write_all_pg=1 <  
→ ../../External_Tools/mProphet/mProphet.R
```

5. Set the output destination by double-clicking on node Output File.

6. Run the workflow.

The resulting output can be found at your selected path, which will be used as input for mProphet. Execute the script on the Terminal (Linux or Mac) or cmd.exe (Windows) in `Example_Data\OpenSWATH\result`. Please use the absolute path to your R installation and the result file:

or for windows

The main output will be called

`OpenSWATH\result\mProphet_all_peakgroups.xls`

with statistical information available in

`OpenSWATH\result\mProphet.pdf`.

Please note that due to the semi-supervised machine learning approach of mProphet the results differ slightly when mProphet is executed several times.

Additionally the chromatogram output (.mzML) can be visualized for inspection with TOPPView.

For additional instructions on how to use pyProphet instead of mProphet please have a look at the PyProphet Legacy Workflow http://openswath.org/en/latest/docs/pyprophet_legacy.html. If you want to use the SQLite-based workflow in your lab in the future, please have a look here: <http://openswath.org/en/latest/docs/pyprophet.html>. The SQLite-based workflow will not be part of the tutorial.

7.6 From the example dataset to real-life applications

The sample dataset used in this tutorial is part of the larger SWATH MS Gold Standard (SGS) dataset which is described in the publication of Roest et al. [21]. It contains one

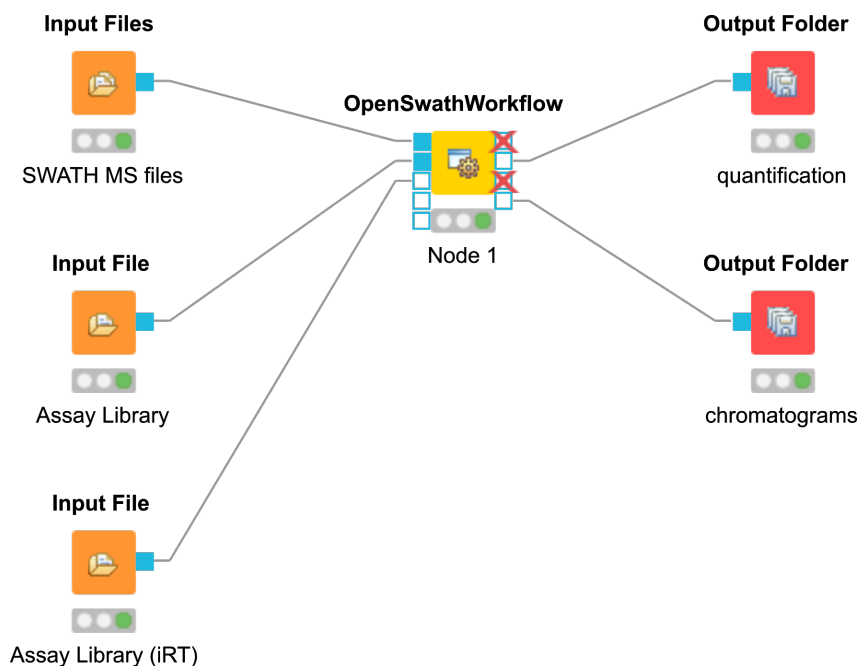

Figure 44: OpenSWATH KNIME Workflow.

of 90 SWATH-MS runs with significant data reduction (peak picking of the raw, profile data) to make file transfer and working with it easier. Usually SWATH-MS datasets are huge with several gigabyte per run. Especially when complex samples in combination with large assay libraries are analyzed, the TOPP tool based workflow requires a lot of computational resources. Additional information and instruction can be found at <http://openswath.org/en/latest/>.

8 OpenSWATH for Metabolomics

8.1 Introduction

We would like to present an automated DIA/SWATH analysis workflow for metabolomics, which takes advantage of experiment specific target-decoy assay library generation. This allows for targeted extraction, scoring and statistical validation of metabolomics DIA data [29], [30].

8.2 Workflow

The workflow follows multiple steps (see Fig. 45).

Candidate identification Feature detection, adduct grouping and accurate mass search are applied on DDA data.

Library construction The knowledge determined from the DDA data, about compound identification, its potential adduct and the corresponding fragment spectra are used to perform fragment annotation via compositional fragmentation trees [31]. Afterwards transitions, which are the reference of a precursor to its fragment ions are stored in a so-called assay library. Assay libraries usually contain additional metadata (i.e. retention time, peak intensities). FDR estimation is based on the target-decoy approach [32]. For the generation of the MS2 decoys, the fragmentation tree-based rerooting method ensures the consistency of decoy spectra [33]. Targeted extraction - The target-decoy assay library is then used to analyse SWATH data.

Targeted extraction Chromatogram extraction and peak-group scoring. This step is performed using an algorithm based on OpenSWATH [29] for metabolomics data.

Statistical validation FDR estimation uses the PyProphet algorithm [30]. To prevent overfitting we chose the simpler linear model (LDA) for target-decoy discrimination in PyProphet, using MS1 and MS2 scoring with low correlated scores.

8.3 Prerequisites

Apart from the usual KNIME nodes, the workflow uses python scripting nodes. One basic requirement for the installation of python packages, in particular pyOpenMS, is a package manager for python. Using conda as an environment manager allows to specify a specific environment in the KNIME settings (File > Preferences > KNIME > Python)

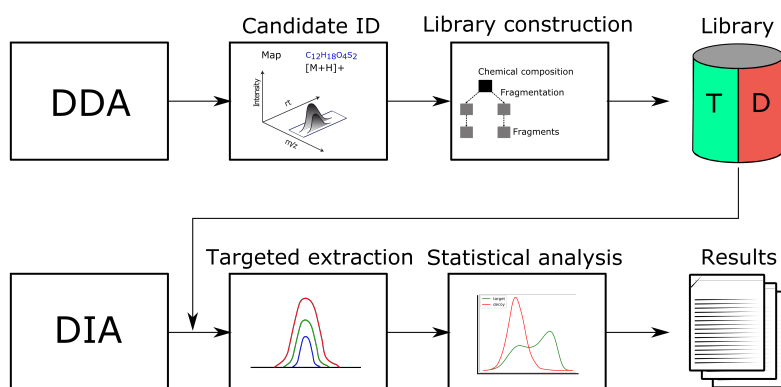

Figure 45: DIAMetAlyzer - pipeline for assay library generation and targeted analysis with statistical validation. DDA data is used for candidate identification containing feature detection, adduct grouping and accurate mass search. Library construction uses fragment annotation via compositional fragmentation trees and decoy generation using a fragmentation tree re-rooting method to create a target-decoy assay library. This library is used in a second step to analyse metabolomics DIA data performing targeted extraction, scoring and statistical validation (FDR estimation).

```
conda create -n py37 python=3.7
```

8.3.1 Windows

We suggest do use a virtual environment for the Python 3 installation on windows. Here you can install miniconda and follow the further instructions.

1. Create new conda python environment
2. Activate py37 environment
3. Install pip (see above)
4. On the command line:

8.3.2 MacOS

We suggest do use a virtual environment for the Python 3 installation on Mac. Here you can install miniconda and follow the further instructions.

1. Create new conda python environment

```
conda activate py37
```

```
python -m pip install -U pip
python -m pip install -U numpy
python -m pip install -U pandas
python -m pip install -U pyprophet
python -m pip install -U pyopenms
```

```
conda create -n py37 python=3.7
```

2. Activate py37 environment
3. On the Terminal:

8.3.3 Linux

Use your package manager apt-get or yum, where possible.

1. Install Python 3.7 (Debian: python-dev, RedHat: python-devel)
2. Install NumPy (Debian / RedHat: python-numpy)
3. Install setuptools (Debian / RedHat: python-setuptools)
4. On the Terminal:

8.4 Benchmark data

For the assay library construction pesticide mixes (Agilent Technologies, Waldbronn, Germany) were measured individually in solvent (DDA). Benchmark DIA samples were prepared by spiking different commercially available pesticide mixes into human plasma metabolite extracts in a 1:4 dilution series, which covers 5 orders of magnitude. The example data can be found here: <https://abibuilder.informatik.uni-tuebingen.de/archive/openms/Tutorials/Data/DIAMetAlyzer/>

8.5 Example Workflow

Example workflow for the usage of the DIAMetAlyzer Pipeline in KNIME (see Fig. 46). Inputs are the SWATH-MS data in profile mode (.mzML), a path for saving the new target-decoy assay library, the SIRIUS 4.0.1 executable, the DDA data (.mzML), custom libraries and adducts for AccurateMassSearch, the min/max fragment mass-to-charge to be able to restrict the mass of the transitions and the path to the PyProphet

```
conda activate py37
```

```
python -m pip install -U pip
python -m pip install -U numpy
python -m pip install -U pandas
python -m pip install -U pyprophet
python -m pip install -U pyopenms
```

```
python -m pip install -U pip
python -m pip install -U numpy
python -m pip install -U pandas
python -m pip install -U pyprophet
python -m pip install -U pyopenms
```

executable. The DDA is used for feature detection, adduct grouping, accurate mass search and forwarded to the AssayGeneratorMetabo. The constructed target library is used by the decoy generation node, which calls various python scripts to parse, reformat the input, call Passatutto and export the target-decoy assay library. The target-decoy assay library is processed with the SWATH-MS data in OpenSWATH. The results are used by PyProphet for scoring and output a list of metabolites with their respective q-value and quantitative information.

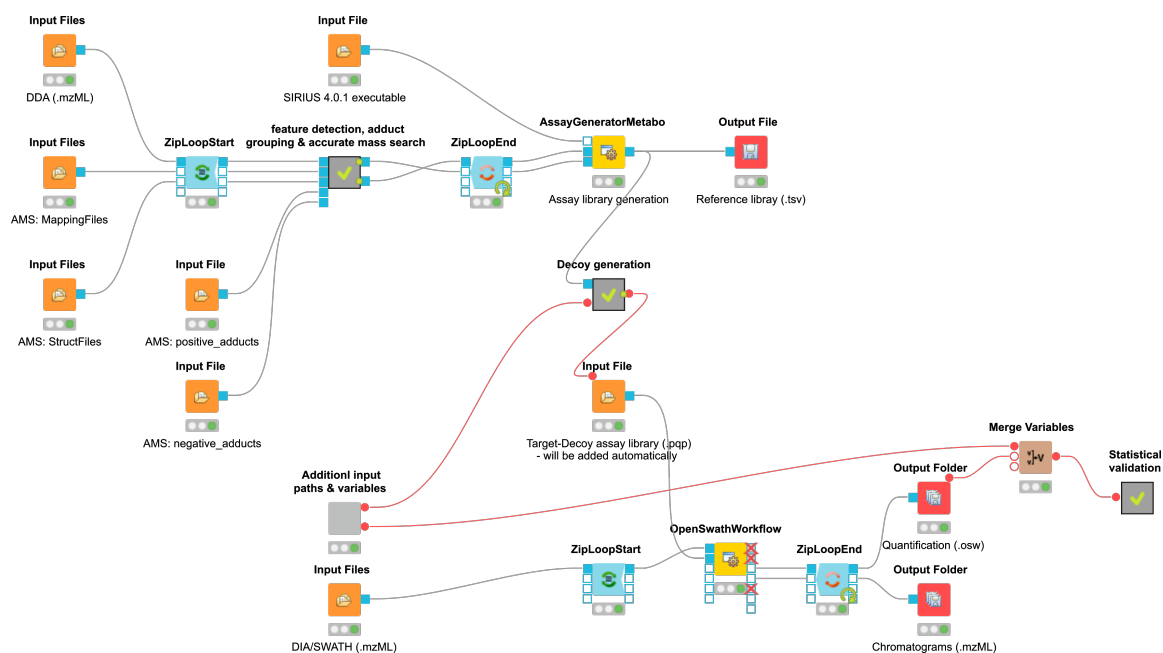

Figure 46: Example workflow for the usage of the DIAMetAnalyzer Pipeline in KNIME

8.6 Run the Workflow

These steps need to be followed to run the workflow successfully:

- Add DDA Input Files (.mzML).
- Specify SIRIUS 4.0.1 executable.

- Specify library files (mapping, struct) for AccurateMassSearch.
- Add positive/negative adducts lists for AccurateMassSearch
- Supply an output path for the SIRIUS workspace in the AssayGeneratorMetabo.
- Specify additional paths and variables, such as an output path for the target-decoy assay library and a path to the pyprophet installation as well as decoy fragment mz filter (min/max).
- Input DIA/SWATH files (.mzML).
- Specify output path in the output folders.
- Ready to go - run the workflow!

8.7 Important parameters

Please have a look at the most important parameters, which should be tweaked to fit your data. In general, OpenMS has a lot of room for parameter optimization to best fit your chromatography and instrumental settings.

FeatureFinderMetabo:

parameter	explanation
<i>noise_threshold_int</i>	Intensity threshold below which peaks are regarded as noise.
<i>chrom_fwhm</i>	Expected chromatographic peak width (in seconds).
<i>mass_error_ppm</i>	Allowed mass deviation (in ppm)

MetaboliteAdductDecharger:

parameter	explanation
<i>mass_max_diff</i>	Maximum allowed mass tolerance per feature..
<i>potential_adducts</i>	Adducts used to explain mass differences - These should fit to the adduct list specified for AccurateMassSearch.

AccurateMassSearch:

parameter	explanation
<i>mass_error_value</i>	Tolerance allowed for accurate mass search.
<i>ionization_mode</i>	Positive or negative ionization mode.

AssayGeneratorMetabo:

```
pyprophet merge --template path_to_target-decoy_assay_library.pqp --out merged.osw
↪ ./*.osw
```

parameter	explanation
<i>min_transitions</i>	Minimal number of transitions (3).
<i>max_transitions</i>	Maximal number of transitions (3).
<i>transitions_threshold</i>	Further transitions need at least x% of the maximum intensity.
<i>out_workspace_directory</i>	Output directory for SIRIUS workspace (Fragmentation Trees).
<i>filter_by_num_masstraces</i>	Features have to have at least x MassTraces. To use this parameter feature_only is necessary.
<i>precursor_mass_tolerance</i>	Tolerance window for precursor selection (Feature selection in regard to the precursor).
<i>precursor_rt_tolerance</i>	Tolerance allowed for matching MS2 spectra depending on the feature size (should be around the FWHM of the chromatograms).
<i>profile</i>	Specify the used analysis profile (e.g. qtof).
<i>elements</i>	Allowed elements for assessing the putative sumformula (e.g. CHNOP[5]S[8]Cl[1]). Elements found in the isotopic pattern are added automatically, but can be specified nonetheless.

OpenSWATH:

parameter	explanation
<i>rt_extraction_window</i>	Extract x seconds around this value.
<i>rt_normalization_factor</i>	Please use the range of your gradient e.g. 950 seconds.

If you are analysing a lot of big DIA mzML files \approx 3-20GB per File, it makes sense to change how OpenSWATH processes the spectra.

parameter	explanation
<i>readOptions</i>	Set cacheWorkingInMemory - will cache the files to disk and read SWATH-by-SWATH into memory
<i>tempDirectory</i>	Set a directory, where cached mzMLs are stored (be aware that this directory can be quite huge depending on the data).

In the workflow pyprophet is called after OpenSWATH, it merges the result files, which allows to get enough data for the model training.

```
pyprophet score --in merged.osw --out scored.osw --level ms1ms2 --ss_main_score  
↪ "var_isotope_correlation_score" --ss_score_filter metabolomics
```

```
pyprophet export-compound --in scored.osw --out scored + "_pyprophet_nofilter_ms1ms2.tsv"  
--max_rs_peakgroup_qvalue 1000.0
```

Afterwards, the results are scored using the MS1 and MS2 levels and filter for metabolomics scores, which have a low correlation.

Export the non filtered results:

Please see the workflow for actual parameter values used for the benchmarking dataset.

The workflow can be used without any identification (remove AccurateMassSearch). Here, all features (known_unknowns) are processed. The assay library is constructed based on the chemical composition elucidated via the fragment annotation. Quantification is possible, unfortunately the decoy generation and FDR estimation for this case is not yet available.

```
python -m pip install -U pip
python -m pip install -U numpy
python -m pip install pyopenms
```

9 An introduction to pyOpenMS

9.1 Introduction

pyOpenMS provides Python bindings for a large part of the OpenMS library for mass spectrometry based proteomics and metabolomics. It thus provides access to a feature-rich, open-source algorithm library for mass-spectrometry based LC-MS analysis. These Python bindings allow raw access to the data-structures and algorithms implemented in OpenMS, specifically those for file access (mzXML, mzML, TraML, mzIdentML among others), basic signal processing (smoothing, filtering, de-isotoping and peak-picking) and complex data analysis (including label-free, SILAC, iTRAQ and SWATH analysis tools).

pyOpenMS is integrated into OpenMS starting from version 1.11. This tutorial is addressed to people already familiar with Python. If you are new to Python, we suggest to start with a Python tutorial (https://en.wikibooks.org/wiki/Non-Programmer%27s_Tutorial_for_Python_3).

9.2 Installation

One basic requirement for the installation of python packages, in particular pyOpenMS, is a package manager for python. We provide a package for *pip* (<https://pypi.python.org/pypi/pip>).

9.2.1 Windows

1. Install Python 3.7 (<http://www.python.org/download/>)
2. Install NumPy (<http://www.lfd.uci.edu/~gohlke/pythonlibs/#numpy>)
3. Install pip (see above)
4. On the command line:

9.2.2 MacOS

We suggest do use a virtual environment for the Python 3 installation on Mac. Here you can install miniconda and follow the further instructions.

```
conda create -n py37 python=3.7 anaconda
```

```
source activate py37
```

1. Create new conda python environment
2. Activate py37 environment
3. On the Terminal:

9.2.3 Linux

Use your package manager apt-get or yum, where possible.

1. Install Python 3.7 (Debian: python-dev, RedHat: python-devel)
2. Install NumPy (Debian / RedHat: python-numpy)
3. Install setuptools (Debian / RedHat: python-setuptools)
4. On the Terminal:

9.2.4 IDE with Anaconda integration

If you do not have python installed or do not want to modify your native installation, another possibility is to use an IDE (integrated development environment) with Anaconda integration. Here, we recommend spyder (<https://www.spyder-ide.org/>). It comes with Anaconda, which is a package and environment manager. Thus the IDE should be able to run a specific environment independent of your systems python installation.

Please execute the installer for your respective platform located in the respective directory for your platform and follow the installation instructions.

After installation the ANACONDA Navigator (Anaconda 3) should be available. Please start the application. To install pyopenms please choose the button "Environments"

```
pip install -U pip
pip install -U numpy
pip install pyopenms
```

```
pip install pyopenms
```

```
pip install -U pip  
pip install -U numpy  
pip install -U pyopenms
```

and click the play symbol of the base environment and "Open Terminal".

Update pip and install pyopenms (MacOS, Linux):

Update pip and install pyopenms (Windows):

Install a local available package:

The local available packages can be found in the directory corresponding to your operating system. Please use the absolute path to the packages for the installation.

Now launch "Spyder" (python IDE) in the home menu.

9.3 Build instructions

Instructions on how to build pyOpenMS can be found online (https://pyopenms.readthedocs.io/en/release_2.4.0/build_from_source.html).

9.4 Scripting with pyOpenMS

A big advantage of pyOpenMS are its scripting capabilities (beyond its application in tool development). Most of the OpenMS datastructure can be accessed using python (<https://abibuilder.informatik.uni-tuebingen.de/archive/openms/Documentation/nightly/html/index.html>). Here we would like to give some examples on how pyOpenMS can be used for simple scripting task, such as peptide mass calculation and peptide/protein digestion as well as isotope distribution calculation.

Calculation of the monoisotopic and average mass of a peptide sequence

Enzymatic digest of a peptide/protein sequence

Use empirical formula to calculate the isotope distribution

For further examples and the pyOpenMS datastructure please see https://pyopenms.readthedocs.io/en/release_2.4.0/datastructures.html.

```
python -m pip install -U pip  
python -m pip install -U numpy  
python -m pip install -U pyopenms
```

```

pip install numpy-1.15.4-cp37*.whl
pip install pyopenms-2.4.0-cp37*.whl
or (in case of windows)
python -m pip install -U numpy-1.15.4-cp37*.whl
python -m pip install -U pyopenms-2.4.0-cp37*.whl

```

```

from pyopenms import *

seq = AASequence.fromString("DFPIANGER")

mono_mass = seq.getMonoWeight(Residue.ResidueType.Full, 0)
average_mass = seq.getAverageWeight(Residue.ResidueType.Full, 0)

print("The masses of the peptide sequence " + seq.toString().decode('utf-8') + " are:")
print("mono: " + str(mono_mass))
print("average: " + str(average_mass))

```

```

enzyme = "Trypsin"
to_digest = AASequence.fromString("MKWVTFISLLLLFSSAYSRGVFRRDTHKSEIAHRFKDLGE")
after_digest = []

EnzymaticDigest = EnzymaticDigestionLogModel()
EnzymaticDigest.setEnzyme(enzyme)
EnzymaticDigest.digest(to_digest, after_digest)

print("The peptide " + to_digest.toString().decode('utf-8') + " was digested using " +
↳ str(EnzymaticDigest.getEnzymeName().decode('utf-8')) + " to:")

for element in after_digest:
    print(element.toString().decode('utf-8'))

```

```

from pyopenms import *

methanol = EmpiricalFormula("CH3OH")
water = EmpiricalFormula("H2O")
wm = EmpiricalFormula(water.toString().decode('utf-8') +
↳ methanol.toString().decode('utf-8'))
print(wm.toString().decode('utf-8'))
print(wm.getElementalComposition())

isotopes = wm.getIsotopeDistribution( CoarseIsotopePatternGenerator(3) )
for iso in isotopes.getContainer():
    print (iso.getMZ(), ":", iso.getIntensity())

```

```
usage: ProteinDigestor.py [-h] [-in INFILE] [-out OUTFILE] [-enzyme ENZYME]
                        [-min_length MIN_LENGTH] [-max_length MAX_LENGTH]
                        [-missed_cleavages MISSED_CLEAVAGES]

ProteinDigestor -- In silico digestion of proteins.

optional arguments:
  -h, --help            show this help message and exit
  -in INFILE            An input file containing amino acid sequences [fasta]
  -out OUTFILE          Output digested sequences in idXML format [idXML]
  -enzyme ENZYME       Enzyme used for digestion
  -min_length MIN_LENGTH
                        Minimum length of peptide
  -max_length MAX_LENGTH
                        Maximum length of peptide
  -missed_cleavages MISSED_CLEAVAGES
                        The number of allowed missed
  ↪ cleavages
```

9.5 Tool development with pyOpenMS

Scripting is one side of pyOpenMS, the other is the ability to create Tools using the C++ OpenMS library in the background. In the following section we will create a "ProteinDigestor" pyOpenMS Tool. It should be able to read in a fasta file. Digest the proteins with a specific enzyme (e.g. Trypsin) and export an idXML output file. Please see [Example_Data ▶ pyopenms](#) for code snippets.

9.5.1 Basics

First, your tool needs to be able to read parameters from the command line and provide a main routine. Here standard Python can be used (no pyOpenMS is required so far).

Open the Anaconda Terminal and change into the [Example_Data ▶ pyopenms](#) directory. Execute the example script.

The parameters are being read from the command line by the function `handle_args()` and given to the `main()` function of the script, which prints the different variables. OpenMS has a `ProteaseDB` class containing a list of enzymes which can be used for digestion of proteins. You can add this to the `argparse` code to be able to see the usable enzymes. From this point onward pyOpenMS is required.

9.5.2 Loading data structures with pyOpenMS

We already scripted enzymatic digestion with the `AASequences` and `EnzymaticDigest` (see above). To make this even easier, we can use an existing class in OpenMS, called `ProteaseDigestion`.

The next step is to use `FASTAFile` class to read the fasta input: The output idXML needs the information about protein and peptide level, which can be saved in the `ProteinIdentification` and `PeptideIdentification` classes.

```
#!/usr/bin/env python
import sys

def main(options):

    # test parameter handling
    print(options.infile, options.outfile, options.enzyme, options.min_length,
    ↪ options.max_length, options.missed_cleavages)

def handle_args():
    import argparse

    usage = """
    usage += "\nProteinDigester -- In silico digestion of proteins."

    parser = argparse.ArgumentParser(description = usage)
    parser.add_argument('-in', dest='infile', help='An input file containing amino acid
    ↪ sequences [fasta]')
    parser.add_argument('-out', dest='outfile', help='Output digested sequences in idXML
    ↪ format [idXML]')
    parser.add_argument('-enzyme', dest='enzyme', help='Enzyme used for digestion')
    parser.add_argument('-min_length', type=int, dest='min_length', help = 'Minimum length
    ↪ of peptide')
    parser.add_argument('-max_length', type=int, dest='max_length', help='Maximum length
    ↪ of peptide')
    parser.add_argument('-missed_cleavages', type=int, dest='missed_cleavages', help='The
    ↪ number of allowed missed cleavages')

    args = parser.parse_args(sys.argv[1:])
    return args

if __name__ == '__main__':
    options = handle_args()
    main(options)
```

```
python ProteinDigester_argparse.py -h
```

```
python ProteinDigester_argparse.py -in mini_example.fasta -out mini_example_out.idXML
↪ -enzyme Trypsin -min_length 6 -max_length 40 -missed_cleavages 1
```

```
# from here pyopenms is needed
# get available enzymes from ProteaseDB
all_enzymes = []
p_db=ProteaseDB().getAllNames(all_enzymes)

# concatenate them to the enzyme argument.
parser.add_argument('-enzyme', dest='enzyme', help='Enzymes which can be used for
↪ digestion: '+ ', '.join(map(bytes.decode, all_enzymes)))
```

```
# Use the ProteaseDigestion class
# set the enzyme used for digestion and the number of missed cleavages
digester = ProteaseDigestion()
digester.setEnzyme(options.enzyme)
digester.setMissedCleavages(options.missed_cleavages)

# call the ProteaseDigestion::digest function
# which will return the number of discarded digestions products
# and fill the current_digest list with digested peptide sequences
digester.digest(aaseq.fromString(fe.sequence), current_digest, options.min_length,
↪ options.max_length)
```

```
# construct a FASTAFile Object and read the input file
ff = FASTAFile()
ff.readStart(options.infile)

# construct and FASTAEntry Object
fe = FASTAEntry()

# loop over the entry in the fasta while using while
while(ff.readNext(fe)):
```

```
idxml = IdXMLFile()
idxml.store(options.outfile, protein_identifications, peptide_identifications)
```

This is the part of the program which unifies the snippets provided above. Please have a closer look how the protein and peptide datastructure is incorporated in the program.

9.5.3 Putting things together

The parameter input and the functions can be used to construct the program we are looking for. If you are struggling please have a look in the example data section ProteinDigestor.py

Now you can run your tool in the Anaconda Terminal ( Example_Data ▶ pyopenms):

9.5.4 Bonus task

Task



Implement all other 184 TOPP tools using pyOpenMS.

```

def main(options):
    # read fasta file
    ff = FASTAFile()
    ff.readStart(options.infile)
    fe = FASTAEntry()

    # use ProteaseDigestion class
    digestor = ProteaseDigestion()
    digestor.setEnzyme(options.enzyme)
    digestor.setMissedCleavages(options.missed_cleavages)

    # protein and peptide datastructure
    protein_identifications = []
    peptide_identifications = []
    protein_identification = ProteinIdentification()
    protein_identifications.append(protein_identification)
    temp_pe = PeptideEvidence()

    # number of dropped peptides due to length restriction
    dropped_by_length = 0

    while(ff.readNext(fe)):
        # construct ProteinHit and fill it with sequence information
        temp_protein_hit = ProteinHit()
        temp_protein_hit.setSequence(fe.sequence)
        temp_protein_hit.setAccession(fe.identifier)

        # save the ProteinHit in a ProteinIdentification Object
        protein_identification.insertHit(temp_protein_hit)

        # construct a PeptideHit and save the ProteinEvidence (Mapping) for the specific
        # current protein
        temp_peptide_hit = PeptideHit()
        temp_pe.setProteinAccession(fe.identifier);
        temp_peptide_hit.setPeptideEvidences([temp_pe])

        # digestion
        current_digest = []
        aaseq = AASequence()
        if (options.enzyme == "none"):
            current_digest.append(aaseq.fromString(fe.sequence))
        else:
            dropped_by_length += digestor.digest(aaseq.fromString(fe.sequence),
            ↪ current_digest, options.min_length, options.max_length)

        for seq in current_digest:
            # fill the PeptideHit and PeptideIdentification datastructure
            peptide_identification = PeptideIdentification()
            temp_peptide_hit.setSequence(seq)
            peptide_identification.insertHit(temp_peptide_hit)
            peptide_identifications.append(peptide_identification)

    print(str(dropped_by_length) + " peptides have been dropped due to the length
    ↪ restriction.")
    idxml = IdXMLFile()
    idxml.store(options.outfile, protein_identifications, peptide_identifications)

```

```

python ProteinDigestor.py -in mini_example.fasta -out mini_example_out.idXML -enzyme
↪ Trypsin -min_length 6 -max_length 40 -missed_cleavages 1

```

10 Quality control

10.1 Introduction

In this chapter, we will build on an existing workflow with OpenMS / KNIME to add some quality control (QC). We will utilize the qcML tools in OpenMS to create a file with which we can collect different measures of quality to the mass spectrometry runs themselves and the applied analysis. The file also serves the means of visually reporting on the collected quality measures and later storage along the other analysis result files. We will, step-by-step, extend the label-free quantitation workflow from section 3 with QC functions and thereby enrich each time the report given by the qcML file. But first, to make sure you get the most of this tutorial section, a little primer on how we handle QC on the technical level.

QC metrics and qcML

To assert the quality of a measurement or analysis we use quality metrics. Metrics are describing a certain aspect of the measurement or analysis and can be anything from a single value, over a range of values to an image plot or other summary. Thus, qcML metric representation is divided into QC parameters (QP) and QC attachments (QA) to be able to represent all sorts of metrics on a technical level.

A QP may (or may not) have a value which would equal a metric describable with a single value. If the metric is more complex and needs more than just a single value, the QP does not require the single value but rather depends on an attachment of values (QA) for full meaning. Such a QA holds the plot or the range of values in a table-like form. Like this, we can describe any metric by a QP and an optional QA.

To assure a consensual meaning of the quality parameters and attachments, we created a controlled vocabulary (CV). Each entry in the CV describes a metric or part/extension thereof. We embed each parameter or attachment with one of these and by doing so, connect a meaning to the QP/QA. Like this, we later know exactly what we collected and the programs can find and connect the right dots for rendering the report or calculating new metrics automatically. You can find the constantly growing controlled vocabulary here:

<https://github.com/qcML/qcML-development/blob/master/cv/qc-cv.obo>.

Finally, in a qcml file, we split the metrics on a per mass-spectrometry-run base or a set of mass-spectrometry-runs respectively. Each run or set will contain its QP/QA we calculate for it, describing their quality.

10.2 Building a qcML file per run

As a start, we will build a basic qcML file for each mzML file in the label-free analysis. We are already creating the two necessary analysis files to build a basic qcML file upon each mzML file, a feature file and an identification file. We use the QCCalculator node from [Community Nodes](#) > [OpenMS](#) > [Utilities](#) where also all other QC* nodes will be found. The QCCalculator will create a very basic qcML file in which it will store collected and calculated quality data.

- Copy your label-free quantitation workflow into a new lfq-qc workflow and open it.
- Place the QCCalculator node after the IDMapper node. Being inside the ZipLoop, it will execute for each of the three mzML files the Input node.
- Connect the first QCCalculator port to the first ZipLoopStart outlet port, which will carry the individual mzML files.
- Connect the last's ID outlet port (IDFilter or the ID metanode) to the second QCCalculator port for the identification file.
- Finally, connect the IDMapper outlet to the third QCCalculator port for the feature file.

The created qcML files will not have much to show for, basic as they are. So we will extend them with some basic plots.

- First, we will add an 2D overview image of the given mass spectrometry run as you may know it from TOPPView. Add the ImageCreator node from [Community Nodes](#) > [OpenMS](#) > [Utilities](#). Change the *width* and *height* parameters to 640x640 as we don't want it to be too big. Connect it to the first ZipLoopStart outlet port, so it will create an image file of the mzML's contained run.
- Now we have to embed this file into the qcML file, and attach it to the right QualityParameter. For this, place a QCEmbedder node behind the ImageCreator and connect that to its third inlet port. Connect its first inlet port to the outlet of the QCCalculator node to pass on the qcML file. Now change the parameter *cv_acc* to **QC:0000055** which designates the attached image to be of type QC:0000055 - MS experiment heatmap. Finally, change the parameter *qp_att_acc* to **QC:0000004**, to attach the image to the QualityParameter QC:0000004 - MS acquisition result details.
- For a reference of which CVs are already defined for qcML, have a look at <https://github.com/qcML/qcML-development/blob/master/cv/qc-cv.obo>.

```
#install.packages("ggplot2")
#install.packages("scales")
```

```
install.packages("ggplot2")
install.packages("scales")
```

There are two other basic plots which we almost always might want to look at before judging the quality of a mass spectrometry run and its identifications: the *total ion current* (TIC) and the *PSM mass error* (Mass accuracy), which we have available as pre-packaged QC metanodes.

Task



Import the workflow from Workflows ▶ Quality Control ▶ QC Metanodes.zip in KNIME: File >> Import KNIME Workflow...

- Copy the Mass accuracy metanode into the workflow behind the QCEmbedder node and connect it. The qcML will be passed on and the Mass accuracy plots added. The information needed was already collected by the QC Calculator.
- Do the same with the TIC metanode so that your qcML file will get passed on and enriched on each step.

R Dependencies: This section requires that the R packages ggplot2 and scales are both installed. This is the same procedure as in section 6.4.5. In case that you use an R installation where one or both of them are not yet installed, open the R Snippet nodes inside the metanodes you just used (double-click). Edit the script in the *R Script* text editor from:

to Press to execute the script.

Note: To have a peek into what our qcML now looks like for one of the ZipLoop iterations, we can add an Output Folder node from GenericKnimeNodes >> IO and set its destination parameter to somewhere we want to find our intermediate qcML files in, for example qc_lfq. If we now connect the last metanode with the Output Folder and restart the workflow, we can start inspecting the qcML files.

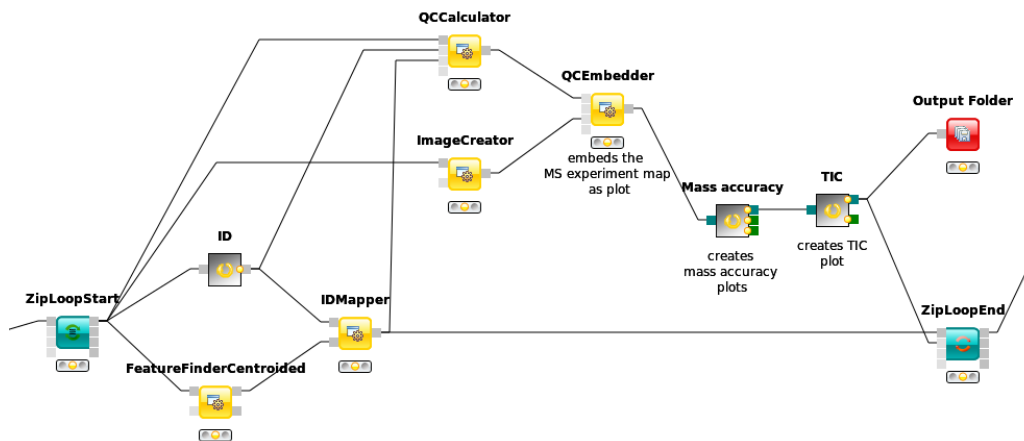

Figure 47: Basic QC setup within a LFQ workflow

```
#install.packages("ggplot2")
library("ggplot2")
ggplot(knime.in, aes(x=peptide_charge)) +
  geom_histogram(binwidth=1, origin =-0.5) +
  scale_x_discrete() +
  ggtitle("Identified peptides charge histogram") +
  ylab("Count")
```

Task



Find your first created qcML file and open it with the browser (not IE), and the contained QC parameters will be rendered for you.

10.3 Adding brand new QC metrics

We can also add brand new QC metrics to our qcML files. Remember the Histogram you added inside the ZipLoop during the label-free quantitation section? Let's imagine for a moment this was a brand new and utterly important metric and plot for the assessment of your analyses quality. There is an easy way to integrate such new metrics into your qcMLs. Though the Histogram node cannot pass its plot to an *image*, we can do so with a R View (table).

- Add an R View (table) next to the IDTextReader node and connect them.
- Edit the R View (table) by adding the *R Script* according to this:
- This will create a plot like the Histogram node on *peptide_charge* and pass it on as an *image*.
- Now add and connect a Image2FilePort node from Community Nodes GenericKnimeNodes Flow to the R View (table).

- We can now use a QCEmbedder node like before to add our new metric plot into the qcML.
- After looking for an appropriate target in <https://github.com/qcML/qcML-development/blob/master/cv/qc-cv.obo>, we found that we can attach our plot to the *MS identification result details* by setting the parameter *qp_att_acc* to *QC:000025*, as we are plotting the charge histogram of our *identified* peptides.
- To have the plot later displayed properly, we assign it the parameter *cv_acc* of *QC:000051*, a *generic plot*. Also we made sure in the *R Script*, that our plot carries a caption so that we know which is which, if we had more than one new plot.
- Now we redirect the QCEmbedders output to the Output Folder from before and can have a look at how our qcML is coming along after restarting the workflow.

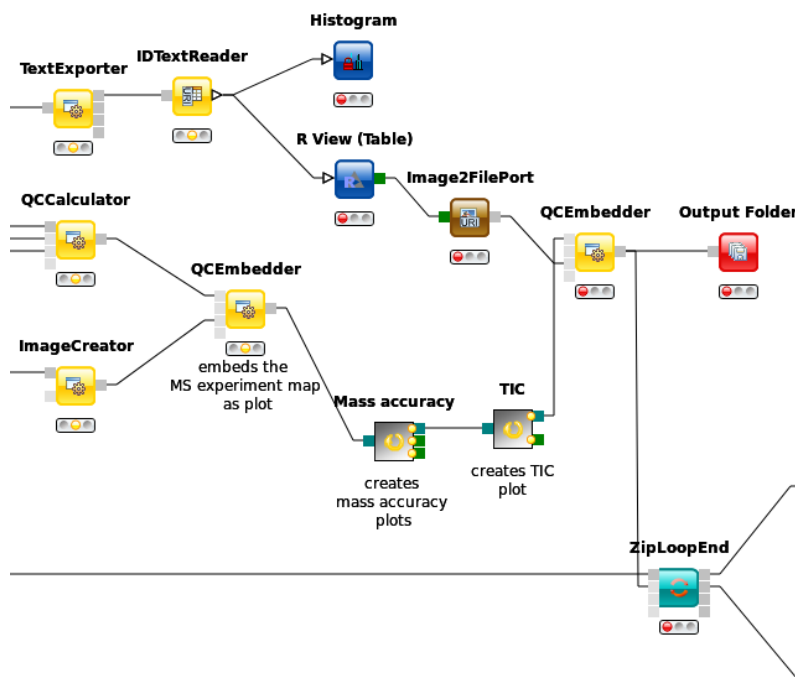

Figure 48: QC with new metric

10.4 Set QC metrics

Besides monitoring the quality of each individual mass spectrometry run analysis, another capability of QC with OpenMS and qcML is to monitor the complete set. The easiest control is to compare mass spectrometry runs which should be similar, e.g. technical replicates, to spot any aberrations in the set.

For this, we will first collect all created qcML files, merge them together and use the qcML onboard *set QC* properties to detect any outliers.

- connect the QCEmbedders output from last section to the ZipLoopEnds second input port.
- The corresponding output port will collect all qcML files from each ZipLoop iteration and pass them on as a list of files.
- Now we add a QCMerger node after the ZipLoopEnd and feed it that list of qcML files. In addition, we set its parameter *setname* to give our newly created set a name - say *spikein_replicates*.
- To inspect all the QCs next to each other in that created qcML file, we have to add a new Output Folder to which we can connect the QCMerger output.

When inspecting the set-qcML file in a **browser**, we will be presented another overview. After the set content listing, the basic QC parameters (like number of identifications) are each displayed in a graph. Each set member (or run) has its own section on the x-axis and each run is connected with that graph via a link in the mouseover on one of the QC parameter values.

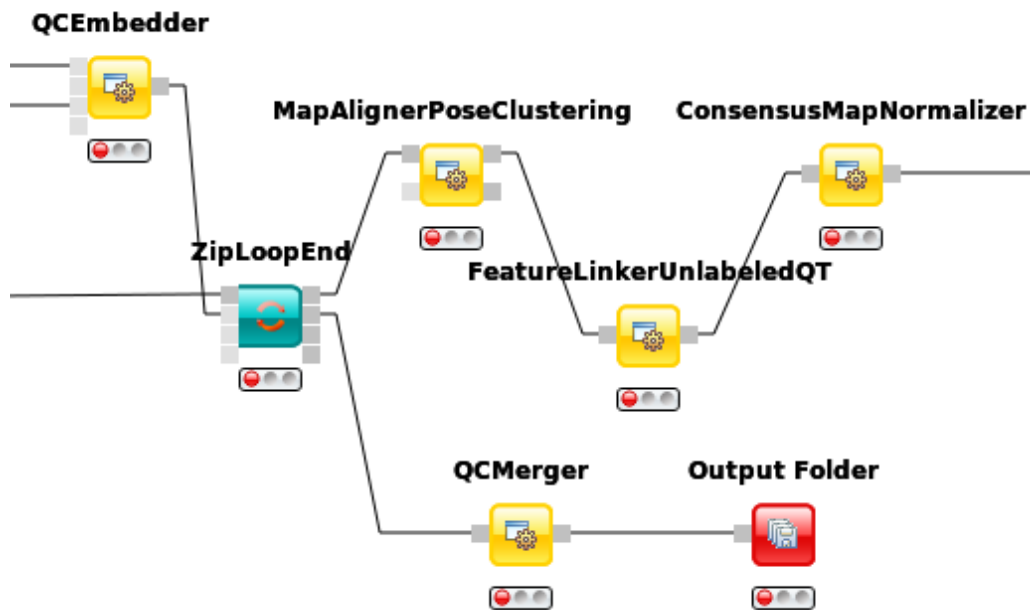

Figure 49: QC set creation from ZipLoop

Task



For ideas on new QC metrics and parameters -as you add them in your qcML files as generic parameters, feel free to contact us, so we can include them in the CV.



11 Troubleshooting guide

This section will show you where you can turn to when you encounter any problems with this tutorial or with our nodes in general. Please see the FAQ first. If your problem is not listed or the proposed solution does not work, feel free to leave us a message at the means of support that you see most fit. If that is the case, please provide us with as much information as you can. In an ideal case, that would be:

- Your operating system and its version (e.g. Windows 8, Ubuntu 14.04)
- Your KNIME version (e.g. KNIME 3.1.2 full, KNIME 3.1.1 core)
- If not full: Which update site did you use for the OpenMS plugin? Trunk (nightly-builds) or Stable?
- Your OpenMS plugin version found under 
- Other installations of OpenMS on your computer (e.g. from the independent OpenMS installer, another KNIME instance etc.)
- The log of the error in KNIME and the standard output of the tool (see FAQ: How to debug)
- Your description of what you tried to do and experienced instead

11.1 FAQ

11.1.1 How to debug KNIME and/or the OpenMS nodes?

- **KNIME:** Start with the normal log on the bottom right of KNIME. In general all warnings and errors will be listed there. If the output is not helpful enough, try to set the logging verbosity to the highest (DEBUG) under Preferences -> KNIME -> Log file log level.
- **OpenMS nodes:** The first step should also be the log of KNIME. Additionally, you can view the output and the errors of our tools by right-clicking on the node and selecting . This shows you the output of the OpenMS executable that was called by that node. For advanced users, you can try to execute the underlying executable in your  folder, to see if the error is reproducible outside of KNIME.

You can look up temporary files that are created by OpenMS nodes not connected to an Output or Viewer Node by right-clicking on a node and selecting the corresponding output view for the output you want to have a look at. The output views are located on the bottom of the menu that shows up after right-clicking. Their icon is a magnifying glass on top of a data table. The names of the output views in that menu may vary from node to node (usually a combination of "file", "out", "output" and optionally its possible extensions). For example for the Input File node you can open the information on the output files by clicking on "loaded file". In any case, a hierarchy of file descriptions will show up. If there are multiple files on that port they will be numbered (usually beginning from 0). Expand the information for the file you want to see and copy its URI (you might need to erase the "file:" prefix). Now open it with an editor of your choice. Be aware that temporary files are subject to deletion and are usually only stored as long as they are actually needed. There is also a Debug mode for the GKN nodes that keeps temporary files that can be activated under Preferences -> KNIME -> Generic KNIME Nodes -> Debug mode. For the single nodes you can also increase the debug level in the configuration dialog under the advanced parameters. You can also specify a log file there, to save the log output of a specific node on your file system.

11.1.2 General

Q: Can I add my own modifications to the Unimod.xml?

A: Unfortunately not very easy. This is an open issue since the selections are hard-coded during creation of the tools. We included 10 places for dummy modifications that can be entered in our Unimod.xml and selected in KNIME.

Q: I have problem XYZ but it also occurs with other nodes or generally in the KNIME environment/GUI, what should I do?

A: This sounds like a general KNIME bug and we advise to search help directly at the KNIME developers. They also provide a FAQ and a forum.

Q: After exporting and reading in results into a KNIME table (e.g. with a MzTabExporter and MzTabReader combination) numeric values get rounded (e.g. from scientific notation 4.5e-10 to zero) or are in a different representation than in the underlying exported file!

A: Please try a different table column renderer in KNIME. Open the table in question, right-click on the header of an affected column and select another Available Renderer by hovering and finally left-clicking.

Q: I have checked all the configurations but KNIME complains that it can not find certain output Files (FileStoreObjects).

A: Sometimes KNIME/GKN has hiccups with multiple nodes with a same name, executed at the same time in the same loop. We have seen that a simple save and restart of KNIME usually solves the problem.

11.1.3 Platform-specific problems

Linux

Q: Whenever I try to execute an OpenMS node I get an error similar to these:

```
/usr/lib/x86_64-linux-gnu/libgomp.so.1: version `GOMP_4.0' not found  
/usr/lib/x86_64-linux-gnu/libstdc++.so.6: version `GLIBCXX_3.4.20' not found
```

A: We currently build the binaries shipped in the OpenMS KNIME plugin with gcc 4.8. We will try to extend our support for older compilers. Until then you either need to upgrade your gcc compiler or at least the library that the tool complained about or you need to build the binaries yourself (see OpenMS documentation) and replace them in your KNIME binary folder

(`YOURKNIMEFOLDER/plugins/de.openms.platform.architecture.version/payload/bin`).

Q: Why is my configuration dialog closing right away when I double-click or try to configure it? Or why is my GUI responding so slow?

A: If you have any problems with the KNIME GUI or the opening of dialogues under Linux you might be affected by a GTK bug. See the KNIME forum (e.g. here or here) for a discussion and a possible solution. In short: set environment variable by calling `export SWT_GTK3=0` or edit `knime.ini` to make Eclipse use GTK2 by adding the following two lines:

```
-launcher.GTK_version
```

```
2
```

macOS

Q: I have problems installing RServe in my local R installation for the R KNIME Extension:

A: If you encounter linker errors while running `install.packages("Rserve")` when using an R installation from homebrew, make sure `gettext` is installed via homebrew and you pass flags to its lib directory. See StackOverflow question 21370363.

Q: Although I `Ctrl`+`Leftclick` `TOPPAS.app` or `TOPPView.app` and accept the risk of a downloaded application, the icon only shortly blinks and nothing happens:

A: It seems like your OS is not able to remove the quarantine flag. If you trust us, please remove it yourself by typing the following command in your Terminal.app:

```
xattr -r -d com.apple.quarantine /Applications/OpenMS-2.3.0
```

Windows

Q: KNIME has problems getting the requirements for some of the OpenMS nodes on Windows, what can I do?

A: Get the prerequisites installer here or install .NET3.5, .NET4 and VCRedist10.0 and 12.0 yourself.

11.1.4 Nodes

Q: Why is my XTandemAdapter printing empty or VERY few results, although I did not use an e-value cutoff?

A: Due to a bug in OpenMS 2.0.1 the XTandemAdapter requires a default parameter file. Give it the default configuration in

```
YOURKNIMEFOLDER/plugins/de.openms.platform.architecture.version/payload/share/
```

```
CHEMISTRY/XTandem_default_input.xml
```

as a third input file. This should be resolved in newer versions though, such that it automatically uses this file if the optional inputs is empty. This should be solved in newer versions.

Q: Do MSGFPlusAdapter, LuciphorAdapter or SiriusAdapter generally behave different/unexpected?

A: These are Java processes that are started underneath. For example they can not be killed during cancellation of the node. This should not affect its performance, however. Make sure you set the Java memory parameter in these nodes to a reasonable value. Also MSGFPlus is creating several auxiliary files and accesses them during execution. Some users therefore experienced problems when executing several instances at the same time.

11.2 Sources of support

If your questions could not be answered by the FAQ, please feel free to turn to our developers via one of the following means:

- File an issue on GitHub
- Write to the Mailing List
- Open a thread on the KNIME Community Contributions forum for OpenMS

References

- [1] OpenMS, OpenMS home page [online]. 7
- [2] M. Sturm, A. Bertsch, C. Gröpl, A. Hildebrandt, R. Hussong, E. Lange, N. Pfeifer, O. Schulz-Trieglaff, A. Zerck, K. Reinert, and O. Kohlbacher, OpenMS - an open-source software framework for mass spectrometry., *BMC bioinformatics* **9**(1) (2008), doi:10.1186/1471-2105-9-163. 7, 83
- [3] H. L. Röst, T. Sachsenberg, S. Aiche, C. Bielow, H. Weisser, F. Aicheler, S. Andreotti, H.-C. Ehrlich, P. Gutenbrunner, E. Kenar, et al., OpenMS: a flexible open-source software platform for mass spectrometry data analysis, *Nature Methods* **13**(9), 741–748 (2016). 7
- [4] O. Kohlbacher, K. Reinert, C. Gröpl, E. Lange, N. Pfeifer, O. Schulz-Trieglaff, and M. Sturm, TOPP—the OpenMS proteomics pipeline., *Bioinformatics* **23**(2) (Jan. 2007). 7, 83
- [5] M. R. Berthold, N. Cebron, F. Dill, T. R. Gabriel, T. Kötter, T. Meinl, P. Ohl, C. Sieb, K. Thiel, and B. Wiswedel, KNIME: The Konstanz Information Miner, in *Studies in Classification, Data Analysis, and Knowledge Organization (GfKL 2007)*, Springer, 2007. 7
- [6] M. Sturm and O. Kohlbacher, TOPPView: An Open-Source Viewer for Mass Spectrometry Data, *Journal of proteome research* **8**(7), 3760–3763 (July 2009), doi:10.1021/pr900171m. 7
- [7] RDKit: Open-source cheminformatics, <http://www.rdkit.org>, [Online; accessed 31-August-2018]. 25
- [8] C. Steinbeck, Y. Han, S. Kuhn, O. Horlacher, E. Luttmann, and E. Willighagen, The Chemistry Development Kit (CDK): An Open-Source Java Library for Chemo- and Bioinformatics, *Journal of Chemical Information and Computer Sciences* **43**(2), 493–500 (2003), PMID: 12653513, doi:10.1021/ci025584y. 25
- [9] L. Y. Geer, S. P. Markey, J. A. Kowalak, L. Wagner, M. Xu, D. M. Maynard, X. Yang, W. Shi, and S. H. Bryant, Open mass spectrometry search algorithm, *Journal of Proteome Research* **3**(5), 958–964 (2004). 30
- [10] A. Chawade, M. Sandin, J. Teleman, J. Malmström, and F. Levander, Data Processing Has Major Impact on the Outcome of Quantitative Label-Free LC-MS Analysis, *Journal of Proteome Research* **14**(2), 676–687 (2015), PMID: 25407311, arXiv:<http://dx.doi.org/10.1021/pr500665j>, doi:10.1021/pr500665j. 30

- [11] M. Choi, C.-Y. Chang, T. Clough, D. Broudy, T. Killeen, B. MacLean, and O. Vitek, MSstats: an R package for statistical analysis of quantitative mass spectrometry-based proteomic experiments, *Bioinformatics* **30**(17), 2524–2526 (2014), doi: 10.1093/bioinformatics/btu305. 39, 40
- [12] M. Choi, Z. F. Eren-Dogru, C. Colangelo, J. Cottrell, M. R. Hoopmann, E. A. Kapp, S. Kim, H. Lam, T. A. Neubert, M. Palmblad, B. S. Phinney, S. T. Weintraub, B. MacLean, and O. Vitek, ABRF Proteome Informatics Research Group (iPRG) 2015 Study: Detection of Differentially Abundant Proteins in Label-Free Quantitative LC-MS/MS Experiments, *J. Proteome Res.* **16**(2), 945–957 (2017), doi: 10.1021/acs.jproteome.6b00881. 40
- [13] T. Huang, M. Choi, S. Hao, and O. Vitek, MSstatsTMT: Protein Significance Analysis in shotgun mass spectrometry-based proteomic experiments with tandem mass tag (TMT) labeling., (2020), doi:10.18129/B9.bioc.MSstatsTMT. 55
- [14] D. S. Wishart, D. Tzur, C. Knox, et al., HMDB: the Human Metabolome Database, *Nucleic Acids Res* **35**(Database issue), D521–6 (Jan 2007), doi:10.1093/nar/gkl923. 69
- [15] D. S. Wishart, C. Knox, A. C. Guo, et al., HMDB: a knowledgebase for the human metabolome, *Nucleic Acids Res* **37**(Database issue), D603–10 (Jan 2009), doi: 10.1093/nar/gkn810. 69
- [16] D. S. Wishart, T. Jewison, A. C. Guo, M. Wilson, C. Knox, et al., HMDB 3.0—The Human Metabolome Database in 2013, *Nucleic Acids Res* **41**(Database issue), D801–7 (Jan 2013), doi:10.1093/nar/gks1065. 69
- [17] J. Griss, A. R. Jones, T. Sachsenberg, M. Walzer, L. Gatto, J. Hartler, G. G. Thallinger, R. M. Salek, C. Steinbeck, N. Neuhauser, J. Cox, S. Neumann, J. Fan, F. Reisinger, Q.-W. Xu, N. Del Toro, Y. Perez-Riverol, F. Ghali, N. Bandeira, I. Xenarios, O. Kohlbacher, J. A. Vizcaino, and H. Hermjakob, The mzTab Data Exchange Format: communicating MS-based proteomics and metabolomics experimental results to a wider audience, *Mol Cell Proteomics* (Jun 2014), doi: 10.1074/mcp.0113.036681. 69
- [18] S. Böcker, M. C. Letzel, Z. Lipták, and A. Pervukhin, SIRIUS: Decomposing isotope patterns for metabolite identification, *Bioinformatics* **25**(2), 218–224 (2009), doi:10.1093/bioinformatics/btn603. 75
- [19] S. Böcker and K. Dührkop, Fragmentation trees reloaded, *J. Cheminform.* **8**(1), 1–26 (2016), doi:10.1186/s13321-016-0116-8. 75

- [20] K. Dührkop, H. Shen, M. Meusel, J. Rousu, and S. Böcker, Searching molecular structure databases with tandem mass spectra using CSI:FingerID, *Proc. Natl. Acad. Sci.* **112**(41), 12580–12585 (oct 2015), doi:10.1073/pnas.1509788112. 75
- [21] H. L. Röst, G. Rosenberger, P. Navarro, L. Gillet, S. M. Miladinovic, O. T. Schubert, W. Wolski, B. C. Collins, J. Malmstrom, L. Malmström, and R. Aebersold, OpenSWATH enables automated, targeted analysis of data-independent acquisition MS data, *Nature Biotechnology* **32**(3), 219–223 (Mar. 2014). 83, 87
- [22] L. C. Gillet, P. Navarro, S. Tate, H. Röst, N. Selevsek, L. Reiter, R. Bonner, and R. Aebersold, Targeted Data Extraction of the MS/MS Spectra Generated by Data-independent Acquisition: A New Concept for Consistent and Accurate Proteome Analysis., *Molecular & Cellular Proteomics* **11**(6) (June 2012), doi:10.1074/mcp.0111.016717. 83
- [23] A. Bertsch, C. Gröpl, K. Reinert, and O. Kohlbacher, OpenMS and TOPP: open source software for LC-MS data analysis., *Methods in molecular biology* (Clifton, N.J.) **696**, 353–367 (2011), doi:10.1007/978-1-60761-987-1_23. 83
- [24] H. L. Röst, T. Sachsenberg, S. Aiche, C. Bielow, H. Weisser, F. Aicheler, S. Andreotti, H.-c. Ehrlich, P. Gutenbrunner, E. Kenar, X. Liang, S. Nahnsen, L. Nilse, J. Pfeuffer, G. Rosenberger, M. Rurik, U. Schmitt, J. Veit, M. Walzer, D. Wojnar, W. E. Wolski, O. Schilling, J. S. Choudhary, L. Malmström, R. Aebersold, K. Reinert, and O. Kohlbacher, OpenMS: a flexible open-source software platform for mass spectrometry data analysis, *Nat. Methods* **13**(9), 741–748 (sep 2016), doi:10.1038/nmeth.3959. 83
- [25] J. Pfeuffer, T. Sachsenberg, O. Alka, M. Walzer, A. Fillbrunn, L. Nilse, O. Schilling, K. Reinert, and O. Kohlbacher, OpenMS - A platform for reproducible analysis of mass spectrometry data, *J. Biotechnol.* **261**(February), 142–148 (2017), doi:10.1016/j.jbiotec.2017.05.016. 83
- [26] L. Reiter, O. Rinner, P. Picotti, R. Huttenhain, M. Beck, M.-Y. Brusniak, M. O. Hengartner, and R. Aebersold, mProphet: automated data processing and statistical validation for large-scale SRM experiments, *Nature Methods* **8**(5), 430–435 (May 2011), doi:10.1038/nmeth.1584. 83
- [27] E. W. Deutsch, M. Chambers, S. Neumann, F. Levander, P.-A. Binz, J. Shofstahl, D. S. Campbell, L. Mendoza, D. Ovelleiro, K. Helsens, L. Martens, R. Aebersold, R. L. Moritz, and M.-Y. Brusniak, TraML—A Standard Format for Exchange of Selected Reaction Monitoring Transition Lists, *Molecular & Cellular Proteomics* **11**(4) (Apr. 2012), doi:10.1074/mcp.R111.015040. 84

- [28] C. Escher, L. Reiter, B. MacLean, R. Ossola, F. Herzog, J. Chilton, M. J. MacCoss, and O. Rinner, Using iRT, a normalized retention time for more targeted measurement of peptides., *Proteomics* **12**(8), 1111–1121 (Apr. 2012), doi:10.1002/pmic.201100463. 84
- [29] H. L. Röst, G. Rosenberger, P. Navarro, L. Gillet, S. M. Miladinović, O. T. Schubert, W. Wolski, B. C. Collins, J. Malmström, L. Malmström, and R. Aebersold, OpenSWATH enables automated, targeted analysis of data-independent acquisition MS data., *Nat. Biotechnol.* **32**(3), 219–23 (2014), doi:10.1038/nbt.2841. 89
- [30] J. Teleman, H. L. Röst, G. Rosenberger, U. Schmitt, L. Malmström, J. Malmström, and F. Levander, DIANA-algorithmic improvements for analysis of data-independent acquisition MS data, *Bioinformatics* **31**(4), 555–562 (2015), arXiv: 9808008, doi:10.1093/bioinformatics/btu686. 89
- [31] K. Dührkop, M. Fleischauer, M. Ludwig, A. A. Aksenov, A. V. Melnik, M. Meusel, P. C. Dorrestein, J. Rousu, and S. Böcker, SIRIUS 4: a rapid tool for turning tandem mass spectra into metabolite structure information, *Nat. Methods* **16**(4), 299–302 (apr 2019), doi:10.1038/s41592-019-0344-8. 89
- [32] J. E. Elias and S. P. Gygi, Target-decoy search strategy for increased confidence in large-scale protein identifications by mass spectrometry, *Nat. Methods* **4**(3), 207–214 (Mar. 2007). 89
- [33] K. Scheubert, F. Hufsky, D. Petras, M. Wang, L. F. Nothias, K. Dührkop, N. Bandeira, P. C. Dorrestein, and S. Böcker, Significance estimation for large scale metabolomics annotations by spectral matching, *Nat. Commun.* **8**(1) (2017), doi:10.1038/s41467-017-01318-5. 89